



TROPICAL AGRICULTURAL RESEARCH AND  
HIGHER EDUCATION CENTER

**Doctoral Program**

**MODELING DYNAMIC SYSTEMS FOR SUSTAINABLE SUPPLY CHAINS: A  
CASE STUDY IN LA FORTUNA, COSTA RICA**

By

Mercedes Montero Vega

A dissertation presented in Partial Fulfillment of the Requirements for the Degree of

**DOCTOR OF PHILOSOPHY**

In Environmental Economics and Rural Business Development

Department of Natural Resource and Environment

Turrialba, Costa Rica, 2016

CATIE  
GRADUATE SCHOOL

**DISSERTATION APPROVAL FORM**

This dissertation of Mercedes Montero Vega submitted  
Student name

For the degree of Doctor of Philosophy entitled:  
"Modelling dynamic systems for sustainable supply chains: a case study in La  
Fortuna".

Has been reviewed in final form and approved, as indicated by the signatures and dates  
given below:

Major Advisor: Eliccer Vargas Date: 28-9-2016  
Eliccer Vargas

Committee Members: Reinhold Muschler Date: 28-03-16  
Reinhold Muschler

Olman Quirós Date: 28.09.2016  
Olman Quirós

Mario Villalobos Date: 28-9-2016  
Mario Villalobos

Dean, Graduate School: Mario Piedra Marín Date: 28/09/16  
Mario Piedra Marín

## Abstract

*La Fortuna, Costa Rica, is a region with high potential for becoming a sustainable destination according to international Global Sustainable Tourism Council (GSTC) standards; however, it lacks local sourcing of fresh agricultural goods, even though some of them there are locally grown. This research describes the agri-food supply chain of four basic selected products (cassava, papaya, plantain and taro) in the region and addresses governance mechanisms, price gaps and overall limitations of an effective supply chain.*

*Price gaps between farm-gate prices received by small- and medium-scale farmers (SMFs) and purchase prices by restaurants demonstrate large differences, ranging from 41% in the case of plantain to 333% in the case of papaya, possibly representing significant additional income for farmers. Governance structures are led by buyers, with farmers playing a price-taker role. Therefore, instead of participating as active members of the supply chain in terms of strategic decision making, they are restricted to the production stages of the supply chain.*

*Small- and medium-scale farmers represent a vulnerable sector of most economies. Since there is often a close relationship between agriculture and poverty, development agendas frequently encourage the capacity of smallholders to identify and produce for niche markets to obtain higher prices and therefore, improve their standards of living.*

*A total of 108 small- and medium-scale farmers were interviewed in La Fortuna, a northern region of Costa Rica, to analyze their supply chain structure, to obtain their perception on fairness of prices and to analyze their partner-selection strategies and overall possibility to strive for sustainable supply-chain management. From the demand perspective, 80 tourists were also interviewed to assess their willingness to pay for sustainable products and organic food.*

*Results show farmers' perceptions of fairness of prices are neither dependent on farmers' education nor the type of negotiation (written contract, verbal contract or no contract) but on the type of buyer. Kruskal Wallis tests showed significant differences in perceptions only dependent on the type of buyer ( $p$ -values = 0.033, 0.004, 0.043) for three of the four variables of analysis, suggesting there are important differences in their perceptions of fair distribution and prices according to their supply chain partner.*

*To address selection of supply chain partners, 12 variables were considered for analysis, based on an extensive literature review on small- and medium-scale farmers, high value-added supply chains and supply-chain-partner selection in agri-food supply chains. A fuzzy Technique for Order of Preference by Similarity to Ideal Solution (TOPSIS) was conducted; this multi-criteria decision-making approach was used to analyze the selection of partners from the perspective of small/medium farmers and from the perspective of restaurants in order to provide insight in addressing local sourcing problems.*

*Results from Fuzzy TOPSIS show that it is more convenient to both farmers and restaurants to trade with each other rather than other actors, according to results from the proposed method; closeness coefficients (CCs) from the restaurants' perspectives, were better for farmers (0.56), while intermediaries received a lower calcification (0.46), which was unexpected since most restaurants (63%) source from intermediaries.*

*From the farmers' perspectives, their best alternatives are to sell to restaurants (0.44) or to local markets (0.44), while the lowest ranked options were small local markets (0.37) and intermediaries (0.38). Nonetheless, CCs are low on both sides.*

*Lack of partnership with small- and medium-scale farmers in food supply chains is a common issue in La Fortuna. A constrained analytical hierarchy process (AHP) was performed to obtain weights of determinant variables for trading, which is important so that the selection of supply-chain partners can be better understood. A gap analysis containing both weights (by AHP) and alternative ranking (by TOPSIS) was done to obtain the distance between two fuzzy numbers: from the perspective of farmers and from the perspective of restaurant decision makers. This gap analysis indicates how much distance there is between the perceptions of both groups in each of the 12 selected variables.*

*Results reveal there are some similarities between the perceptions of farmers and restaurant managers regarding price, quality and transparency of transactions; however, there are other aspects such as organic production and environmental practices that are not aligned in relative importance among them. Results suggest a relationship between the gap and the experience of farmers and restaurant owners or decision makers(managers); when farmers have 15 years or more of experience and restaurant owners more than 10 years, their gap closes when compared to the distance between inexperienced farmers and restaurants; this gap ranges from 0.55 for experienced actors to 0.34 for inexperienced actors.*

*Suggestions for improving trading mechanisms among small- and medium-scale farmers with the tourism sector tilt toward installing farmer leaders in the region who can teach other farmers how to improve in terms of production and market access. The lack of farmers' organizations is a restriction when considering options such as cooperatives to lead the supply chain; in addition, certification mechanisms are nonexistent for these farmers, therefore aiming for coordination from this perspective would not be possible, at least in the short run.*

*Lack of information about farmers' locations and accurate estimation of population size was a challenge. Multiple visits to the region were needed simply to locate farmers and to estimate the most important regions to visit; sample sizes for tourists would need to be increased to have accurate estimates.*

*Responses from farmers were difficult to obtain and questions needed to be revised and re-formulated; comparisons of relative importance of variables were not understandable to farmers and therefore a workshop was conducted to address relative importance visually.*

*There were significant differences in perceptions for selected variables when participants were asked individually and when these were addressed in a group. Further research is necessary to have more conclusive estimates and conclusions.*

# Contents

<b>List of figures</b>	<b>4</b>
<b>List of tables</b>	<b>5</b>
<b>List of acronyms</b>	<b>7</b>
<b>1. Introduction</b>	<b>8</b>
<b>2. Theoretical bases</b>	<b>12</b>
2.1 Conceptual framework	12
Sustainable development	12
Sustainable tourism and sustainable destinations	15
Supply chain theories	17
2.2 Literature review	27
Sustainable development	27
Sustainable tourism	29
Sustainable supply chain management	32
Organization of smallholders	35
<b>3. Assumptions</b>	<b>46</b>
<b>4. Methods</b>	<b>48</b>
4.1 Location	48
4.2 Quantitative and qualitative methods	50
Qualitative methods	51
Quantitative Methods	52
Sample size	53
Fuzzy logic	54
Fuzzy AHP	54
Fuzzy TOPSIS	66
<b>5. Fresh supply chains for sustainable destinations: case study in La Fortuna</b>	<b>73</b>
5.1 Introduction	73
5.2 Literature Review	74
Supply Chain Management	74
Supply chains and governance mechanisms	75
5.3 Methods	77
Methods for data collection: farmers	77
Methods for data collection: hotels and restaurants	78
5.4 Results	78
Supply chain analysis	78
Input sources	78
Farmers	79
Local buyers	82

Exports and the Costa Rican market	83
Supporting actors	83
Price analysis	85
5.5 Discussion	86
5.6 Conclusion and recommendations	87
<b>6. Are prices fair in agriculture? A bottom-up smallholder perspective: Case study in La Fortuna, Costa Rica</b>	<b>89</b>
6.1 Introduction	89
6.2 Methods	91
6.3 Results and discussion	92
6.4 Conclusion	100
6.5 Recommendations	100
<b>7. Sustainable supply chain selection: multi-criteria Fuzzy TOPSIS analysis in an agricultural-tourism framework</b>	<b>102</b>
7.1 Introduction	102
7.2 Literature review	103
Literature review on sustainable tourism	103
Agriculture supply chain and organization of SMFs	104
7.3 Methods	107
7.4 Numerical implementation	112
7.5 Results and discussion	114
<b>8. Gap analysis through constrained AHP and fuzzy TOPSIS: case study for La Fortuna.</b>	<b>122</b>
8.1 Introduction	122
8.2 Methods	123
8.3 Numerical implementation	127
8.4 Results and discussion	129
8.5 Conclusions and recommendations	133
<b>9. General overview and conclusions</b>	<b>136</b>
9.1 La Fortuna's fresh product supply chain	136
9.2 The perspective of farmers on fairness of agricultural prices	138
9.3 Methods for supply chain coordination	139
<b>10. Recommendations</b>	<b>143</b>
<b>Acknowledgements</b>	<b>144</b>
<b>References</b>	<b>145</b>
<b>Annexes</b>	<b>162</b>

Annex 1. Questionnaire for hotels and restaurants_____	163
Annex 2. Questionnaire for farmers. _____	166
Annex 3. Guide for La Fortuna´s Stakeholders: In-depth Interviews _____	169
Annex 4. Guide for La Fortuna´s Farmer: In-depth Interviews _____	170



## List of figures

Figure 1. Evolution of the global value chain concept .....	18
Figure 2. Diagram of the Filière approach.....	19
Figure 3. Generic value chain activities .....	22
Figure 4. Five global value chain governance structures.....	26
Figure 5. Membership function representation .....	57
Figure 6. Fuzzy triangular number representation .....	58
Figure 7. Linguistic variables for the importance weight of each criterion.....	58
Figure 8. AHP hierarchy structure .....	60
Figure 9. Proposed hierarchical method for variable ranking and identification .....	61
Figure 10. Map of Costa Rica and La Fortuna .....	74
Figure 11. Frequency distribution of selected products.....	81
Figure 12. Supply chain of selected fresh agricultural produce, La Fortuna, 2015.....	85
Figure 14. Payments farmers receive are enough to provide their families with good opportunities .....	94
Figure 13. Price of agricultural products is fair .....	94
Figure 15. There are many obstacles for farmers to sell their products at a good price. ....	95
Figure 16. People who engage in other economic activities rather than agriculture have better opportunities than farmers do. ....	95
Figure 17. Payments farmers receive are enough to provide their families with good opportunities, by type of buyer .....	98
Figure 18. Price of agricultural products is fair, by type of buyer.....	98
Figure 19. People who engage in other economic activities rather than agriculture have better opportunities than farmers do by type of buyer. ....	99
Figure 20. There are many obstacles for farmers to sell their products at a good price by type of buyer .....	99
Figure 21. Membership function representation.....	108
Figure 22. Representation of gaps between the perceptions of small and medium farmers and restaurants .....	133

## List of tables

Table 1. Top-down and bottom-up local and regional development approaches .....	13
Table 2. Supply chain and value chain definitions .....	33
Table 3. Small and medium farmer classification in Costa Rica.....	35
Table 4. Empirical restricting factors for creation of agriculture and tourism linkage.....	38
Table 5. Social Development Index per district of San Carlos.....	50
Table 6. Example for linguistic variables and fuzzy values .....	62
Table 7. Transformation of linguistic variables into fuzzy numbers.....	63
Table 8. Individual fuzzy comparison matrix example .....	63
Table 9. Transformation of linguistic variables to fuzzy numbers .....	63
Table 10. AHP fuzzy values and their interpretation.....	64
Table 11. Criteria weighed by decision makers.....	68
Table 12. Alternative rating by decision makers .....	68
Table 13. Weighted normalized fuzzy decision matrix .....	71
Table 14. Example of distances from FPIS and FNIS for alternatives.....	72
Table 16. Characterization of poor and high performance of a supply chain.....	75
Table 15. Socioeconomic levels of La Fortuna’s population, 2015 .....	79
Table 17. Income from agriculture and education level of farmers, La Fortuna, 2015 .....	80
Table 18. Frequency of supply chain partner selection for farmers, .....	82
Table 19. Frequency of supply chain partner selection for restaurants, .....	82
Table 20. Prices received by farmers per type of buyer of fresh products, La Fortuna, 2015* ..	85
Table 21. Prices paid by restaurants per type of seller of fresh produce, La Fortuna, 2015* ..	86
Table 22. Example of variable detail for capital cost estimation.....	94
Table 23. Farmers’ perceptions on fairness statements by .....	96
Table 24. Farmers perception on fairness statements by education level*.....	96
Table 25. Farmers perception on fairness by type of buyer*.....	97
Table 26. Average price paid by tourists per person per meal in La Fortuna, Costa Rica .....	99
Table 27. Willingness to pay for organic food in La Fortuna, Costa Rica, .....	100
Table 28. Linguistic variables and their fuzzy values .....	109
Table 29. Aggregated weights for decision makers, La Fortuna, 2015 .....	114
Table 30. Aggregated rankings of criteria and alternatives. La Fortuna, 2015 .....	115
Table 31. Weighted normalized fuzzy decision matrix, La Fortuna, 2015 .....	116
Table 32. Graphic representation of weighted normalized fuzzy decision matrix, La Fortuna, 2015 .....	117
Table 33. FNIS, FPIS and CC for each alternative and decision maker,.....	118
Table 34. CC by alternative with segmented variables, La Fortuna, 2015.....	119
Table 35. AHP fuzzy values and their interpretation for AHP .....	124
Table 36. Membership function of linguistic scale for estimation of weights .....	128
Table 37. Linguistic variables and their fuzzy values for alternative ranking.....	128
Table 38. Pairwise comparison matrix for farmers.....	129
Table 39. Pairwise comparison matrix for restaurants .....	129

Table 40. General Gap Analysis .....	131
Table 41. Gap Analysis for farmers and restaurants with low experience .....	132
Table 42. Gap analysis for experienced farmers and restaurants .....	132

## List of acronyms

**ADIFORT:** Development Association of La Fortuna  
**AHP:** Analytical Hierarchy Process  
**CACORE:** Costa Rican Chamber of Restaurants  
**CANAECO:** Costa Rican National Chamber for Ecotourism and Sustainable Tourism  
**CENADA:** National Center for Procurement and Distribution of Food  
**DM:** Decision makers  
**EM:** Equilibrium Models  
**FAO:** Food and Agriculture Organization  
**FNIS:** Fuzzy Negative Ideal Solution  
**FPIS:** Fuzzy Positive Ideal Solution  
**GSTC:** Global Sustainable Tourism Council  
**HDI:** Human Development Index  
**ICT:** Costa Rica Tourism Institute  
**INA:** National Learning Institute  
**INEC:** National Statistics and Census Institute, Costa Rica  
**IPC:** Consumer Price Index  
**LCA:** Life-Cycle Assessment  
**MAG:** Ministry of Agriculture (Costa Rica)  
**MCDM:** Multi-Criteria Decision Making  
**SDI:** Social Development Index  
**SC:** Supply Chain  
**SSCM:** Sustainable supply chain management  
**SCM:** Supply Chain Management  
**SCOR:** Supply Chain Operations Reference  
**SMF:** Small- and Medium-Scale Farmers  
**TEC:** Technical Institute of Costa Rica  
**TOPSIS:** Technique for Order of Preference by Similarity to Ideal Solution  
**UCR:** University of Costa Rica

# 1. Introduction

This research was conducted in La Fortuna, San Carlos, in the northern region of Costa Rica. La Fortuna is one of the most important touristic regions of the country and its potential for sustainable development and sustainable tourism has been addressed in some studies (Estado de la Nación 2007), (Matarrita-Cascante *et al.* 2010) and (Rivera and Leon 2005). Nonetheless, sustainable development for sustainable destinations assume an inclusion of the first links of the supply chain, which according to (S. Canedo-Rivas 2012), are still missing. In this case agricultural products, although produced in the region, are not sourced locally.

La Fortuna was traditionally an agricultural region, and therefore agricultural production used to be one of the main economic engines of rural livelihoods. However, in spite of this agricultural production, hotels and restaurants from La Fortuna do not source their fresh products locally but from larger companies located in the Greater Metropolitan Area of the country (Canedo-Rivas 2012). Analysis of the fresh food supply chain and linking it to sustainable development of the host community can lead to development of policy strategies for regional development

Tourism has been included in the development agenda because of its potential to contribute to a more sustainable development for host communities. Analysis of a sustainable destination analysis should include, based on its core meaning, not only all of its main actors but also their coordination along the supply chain (GSTC 2013).

Relationships among actors can be better understood by the analysis of different transaction costs among them, which are based on their intrinsic and environmental characteristics as well as other economic and social variables that define how actors interact (Williamson 1985) . Linkages between social partners toward economic decisions remain largely unexplored (Granovetter 2005), and therefore this research is based on the analysis of these linkages, transactions and peculiarities of the agricultural sector related to touristic regions in developing countries—in this case, Costa Rica.

Although tourism can be a path toward a region's sustainable development, there are no clear strategies on how to achieve sustainable destinations via their different supply chains and their management. Current research shows that since 2002, supply chain management has been analyzed from an economic perspective and from 2006 it has shifted to the fulfillment of legal requirements (Teuteberg and Wittstruck 2010), yet holistic approaches of sustainable development have had less presence in the research agenda.

Even though, theoretically, supply chains are managed by their focal companies (Seuring and Müller 2008), in the case of tourism in La Fortuna, there is not one focal company but a set of restaurants and hotels that in some way or another indicate the requirements for belonging to the supply chain or to the tourism cluster. Apparently, in La Fortuna, there is a set of companies that handle their own supply chains independently (Canedo-Rivas 2012).

Therefore there is no regional leader managing the supply chain and considering value-added aspects, such as the development value added either through new products or through new managerial strategies, such as the inclusion of farmers.

Reasons for the failure to include smallholders in markets are varied. Overall (de Janvry *et al.* 1991) state that they occur when transaction costs are higher than market prices and therefore, markets are not used. However, there is a common understanding that agricultural smallholders should not be treated as a homogeneous group (IFC 2013), as special attention to peculiarities, realities and background of farmers is needed for analysis of governance structures.

Peculiarities of smallholders signify that no single model for strengthening their supply chains can apply universally (IFC 2013). The characteristics of actors and products and governance mechanisms (Gereffi *et al.* 2005) partially define the dynamics, possibilities and strategies for successfully linking actors along supply chains.

Smallholders are traditionally recognized as having partial integration in the market as well as limitations for operating under market principles (Friedmann 1980). The implications for smallholder agriculture in the new forms of agri-food governance can be overstated; nonetheless, the new forms of agri-food governance are buyer-driven and have developed sophisticated participation rules (Vorley 2001). Seuring y Müller (2008) mention that sustainable supply chain management is achieved by improving relationships among supply chain partners, which is the objective of any sustainable destination, according to GSTC.

There is not a general procedure for defining the strategy to include small and medium farmers in a sustainable relationship with other stakeholders along the supply chain because of the different contexts and realities smallholders face, yet top-down policies have usually failed to achieve regional development (Pike *et al.*, 2006). World organizations have also developed top-down projects rather than bottom-up ones that have not improved development goals or poverty alleviation to the extent desired, (Zapata *et al.* 2011).

Agricultural activities and those directly involved in the production stages have proven to be related to low development standards in poor regions, (World Bank 2008). This relationship between agriculture and low development is also a reality for rural Costa Rica, in which traditionally rural agricultural regions are less developed than urban ones (UNDP 2011).

Tourism in Costa Rica is traditionally referred to internationally as green due to conservation practices and is theoretically linked to agricultural clusters. According to Porter (2008), linkages among clusters include a close relationship between hospitality and tourism, transportation and logistics, and agricultural products.

The linkage analysis within the supply chain management framework is understood as one that «encompasses all activities associated with the flow and transformation of goods from

the raw materials stage (extraction) through to the end user, as well as the associated information flows» (Handfield 1999).

There is evidence supporting the importance of appropriate linkages for achieving economic and environmental sustainability for the rural communities and for tourism (R. Sims 2009). Appropriate linkages refers to value creation from sourcing from regional agricultural products instead of sourcing from larger distances and creating value for both (all) partners.

According to Germann-Molz (2004) and Long (2004), the relationship between agriculture and tourism has remain unexplored. However, several case studies regarding community-based tourism in developing regions (Ruiz-Ballesteros 2011), (Zapata *et al.* 2011), (Gascón 2012), (Le *et al.* 2012) demonstrate how tourism can help alleviate poverty and provide tools for development. Therefore, there is an opportunity to analyze the possible win-win strategies within these sectors leading to a sustainable organizational structure in a region that is aiming for sustainable tourism certification. This proposal includes a dynamic and complex sustainable development approach with no focal company to guide or manage the supply chain.

As previously mentioned, a full understanding is lacking on how linkages and strategies should be planned in these particular conditions: working with a holistic approach, with smallholders and with the tourism industry in developing countries. Nonetheless, Farrell and Twining-Ward (2005) suggested that the analysis of sustainable tourism must be within a complex adaptive system because events do not occur in a simple linear thread, according to the ecosystem ecologists who were the first to propose a complex system analysis.

Criticism on the lack of quantitative methods for supply chain analysis, according to a literature review on this topic by Seuring (2013), points to a knowledge gap in how to model strategies for creating linkages in a sustainable supply chain management under the particular circumstances mentioned here.

Including smallholders in the development of a sustainable destination is a key aspect of this study due to the parameters of sustainable destination. Therefore, small and medium farmers' peculiarities and conditions should be analyzed in detail, according to their capacities and to the adaptability according to restricting and enabling factors for collaborating in value chains.

The main focus of this research is to propose a quantitative approach for carrying out a holistic analysis of how small and medium farmers and restaurants can improve their business relationships in order for this region to strive for sustainable development, based on achieving a sustainable destination concept—the region already has several characteristics that make it suitable for sustainable tourism.

The main determinant factors (variables) from the demand and supply sides of the supply chain that results in win-win situations would be modeled within the three main constructs of

sustainable development: economic, social and environmental factors (WCED 1987). According to the model, variables and their interactions can be assessed for understanding supply chain systemic functioning and address policy issues for achieving sustainable destinations for agricultural-touristic regions.

**Research question:** How can fresh-food sustainable supply chains be modeled within a sustainable tourism destination from a holistic perspective?

**General objective:**

Evaluate holistic approaches for developing sustainable food supply chains in sustainable destinations in La Fortuna.

**Specific objectives:**

1. Analyze the current state of the supply chain in terms of sustainable development, based on the Global Value Chain Concept.
2. Identify dynamic variables that lead to the inclusion of small and medium farmers in the agriculture-tourism supply chain
3. Propose intervention strategies to create a sustainable supply chain for sustainable destinations based on requirements of smallholder and restaurant managers
4. Analyze knowledge gaps for further research



## 2. Theoretical bases

The following topics are the basis of supply chain management and governance structures, as well as the main conceptual framework referring to sustainable development and sustainable tourism.

### 2.1 Conceptual framework

#### Sustainable development

Since the Brundtland Commission Report in 1987, the term *sustainable development* has been included in most international development summits, forums and goals, but operational strategies are still blurry because of the term's vagueness and flexibility in interpretation (Waas *et al.* 2011). However, the most popular definition of sustainable development was that presented in the World Commission for Environmental Development: "Humanity has the ability to make development sustainable to ensure that it meets the needs of the present without compromising the ability of future generations to meet their own needs" (WCED 1987).

The term itself provides two important issues that have been addressed by many development research agendas. First, sustainable development includes development in economic, environmental and social issues that were not considered essential before 1987. Second, the need for inter- and intra- generational equity. This second aspect includes a rational equity between present and future generations as well as a search for national, regional and community equality for a healthy environment, asset provision and socioeconomic development (WCED 1987).

Although sustainable development is not a clear practical concept and has had abundant interpretations, Gibson (2006) suggests essential commonalities of shared concerns, principles and insights for sustainable development assessment. Consequently, definitions of sustainability often include all the following facts, concerns and peculiarities:

1. Sustainability concerns include socioeconomic and biophysical matters and their interdependences; therefore, sustainability concerns are comprehensive.
2. Human and ecological effects should be addressed, but these are dynamic, multi-scalar complex systems whose full description is impossible and predictions uncertain.
3. Greater community and ecological sustainability are needed, not merely a minimization of negative effects, which is not enough for sustainable development.
4. Corrective actions must include complex systems and multi-criteria objectives.
5. Sustainability requires recognition of both inviolable limits and endless opportunities for creative innovation.
6. The aim of sustainability is multiple reinforcement gains, not balancing on compromises and trade-offs, which are only accepted as last resource.

7. The notion and pursuit of sustainability is both universal and context-dependent.
8. The means and ends of sustainability are intertwined: there is no state of sustainability, but a continuum.

The abovementioned items, although they are broad concepts, characterize the understanding of sustainability to a significant extent, such so that Elliot (2013) refers to these items as the shared essentials of sustainable development.

Regarding development and its conceptions and empirical applications, Pike *et al.* (2006) contend “there are multiple and variable reasons for local and regional development policy failures.” Some are internal to the policy design and implementation and some are external. Deficient education or skills, weak infrastructure and poor social and institutional contexts have jeopardized policy efforts for development. Much of the failure in these strategies has as a trigger the imbalance of policies—for example, much effort is focused on investment in infrastructure while the host community does not have the appropriate social conditions to support the new infrastructure.

In addition, failure of regional development strategies stems from the replication of standardized policies around the world, despite a previous study of social, economic, environmental and cultural characteristics (Pike, *et al.* 2006). The main differences of approaches are summarized in Table 1.

Table 1. Top-down and bottom-up local and regional development approaches

<b>Traditional development policies</b>	<b>Local and regional development</b>
Decisions about areas where intervention is needed are taken from the national center—top-down approach.	Promotion of development in all territories with the initiative often coming from below.
Managed by the national center administration.	Decentralized, vertical cooperation between different tiers of government and horizontal cooperation between public and private bodies.
Sectorial approach to development.	Territorial approach to development.
Development of large industrial projects that foster other economic activities.	Use of development potential of each area to stimulate a progressive adjustment of the local economic system to the changing economic environment.
Financial support, incentives and subsidies as the main factors of attraction of economic activities.	Provision of key conditions for the development of economic activity.

*Source: (Pike et al. 2006)*

Social and economic benefits from regional and local approaches include empowerment of local societies, transparency, and accountability of local and regional institutions for civil development. Economic activities embedded in the social context of the region are more capable of withstanding changes and local and regional economic development strategies contribute to improvement of quality of jobs (Pike *et al.* 2006).

There have been several approaches to regional development. Pike *et al.* (2006) reveal the following as the most transcendental regional and local development perspectives and comment on their evolution.

Neoclassic growth of local and regional convergence: analyzes static rather than dynamic economic equilibrium models. Regional growth determines regional income, welfare and therefore development. Within this framework, development focus is upon the long-run reduction of disparities. Regional growth upon this approach is dependent on capital, labor and technological growth. According to Martin and Sunley (1998)—disparities are temporary, in the long run, capital and labor would diffuse along territories and they will converge, providing a steady growth and lower inequality between regions.

The neoclassic approach also deals with comparative advantage of regions, *i.e.* nations and regions specialize in economic activities in which they hold a comparative advantage by using their abundant factor of production more intensively due to natural factor endowments. Trade is based upon different factor endowments and it can provide inter-region convergence. Nonetheless, there is supporting evidence that convergence into economic equality does not necessarily occur across regions and nations.

Keynesian theories of local and regional divergence: As in the neoclassic approach, development is understood as the reduction of disparities among regions, yet, instead of a factor endowment approach, Keynes proposes a market demand approach. The potential of markets to reduce disparities is not spontaneous but it can be managed by the state through policy. Criticism of this approach peaked regarding agricultural subsidies and the deadweight losses of economies.

Theories of structural and temporal change: Contrary to both of the aforementioned perspectives, theories of structural and temporal change center the analysis on the dynamic historical and evolutionary processes. These theories have broadened the spectrum of analysis to include production technology, consumption and governance institutions.

Institutionalism and socioeconomic theories: These, as an evolution of structural and temporal change, seek to understand peculiarities and underlying characteristics, distinctive local assets and economic capabilities. “The institutionalist approach interprets particular forms of institutional organization as the root causes and explanations of the conditions that promote or inhibit the growth and development of localities and regions” (Pike *et al.* 2006).

Innovation, knowledge and learning theories: Innovation on development research has tilted to a dynamic and interactive model instead of a static one. These theories recognize the importance of interactions in regional development and learning from a regional perspective. More self-aware and self-involved localities would also be more able to adapt to economic changes and absorb positive externalities.

The extended neoclassic theories are subdivided as follows;

1. Endogenous growth theories: Contrary to the treatment of factors as exogenous, endogenous theories have introduced increasing returns into the neoclassical production function to determine long-run growth rates within the model (endogenously).
2. Geographic economics: Focus is on the role of localities and regions in the determination of trading performance. In contrary to other development approaches, in this case development is perceived as increasing income through the improvement of regional competitiveness. Policy regarding geographic economics is based upon trade and support to the most capable geographic regions.
3. Competitive advantage and clusters: This approach proposed by Michael Porter is linked to value chains and therefore will be discussed with more detail in section 1.1.3: Supply Chain Theories.

### **Sustainable tourism and sustainable destinations**

In association with the term *sustainable development*, *sustainable tourism*, according to WTO (2001), is described as follows:

[It] meets the needs of present tourists and host regions while protecting and enhancing opportunities for the future. It envisions managing all resources in such a way that economic, social and aesthetic needs are fulfilled while maintaining cultural integrity, essential ecological processes, biological diversity and life support systems.

There is a substantial need for social equity provided by local employment for skilled and unskilled jobs and the capacity building to comply with these employment requirements. According to Font and Harris (2004) strategies should include appropriate infrastructure, education and cultural awareness and local participation in decision-making processes. Therefore, tourism development must provide educational programs that address these issues, in private and public educational institutions, as well as infrastructure development and overall local participation.

Concerning the definition of sustainable development, Sneddon *et al.* (2006), comment on the necessity of creating a more conceptually potent and politically effective set of ideas that encompass an empowering tale. However, initiatives for practical action toward sustainable development are mainly based on certification programs.

Regarding the tourism industry, certifications have also become an important tool for sustainability assessment. Tourist requirements are dynamic and determine travel decisions, *for example, in choosing a destination* (Liu 2003). According to current trends, headed to a more sustainable industry, tourists are becoming increasingly aware of sustainability implications of tourism development (Wehrli *et al.* 2011).

The United Nations Environment Program (UNEP) and the World Tourism Organization (WTO) have created the following 12 aims for sustainable tourism to address sustainable tourism development within a common framework (UNEP/UNWTO 2005).

1. Economic Viability: to ensure the viability and competitiveness of tourism destinations and enterprises, so that they are able to continue to prosper and deliver benefits in the long term.
2. Local Prosperity: to maximize the contribution of tourism to the economic prosperity of the host destination, including the proportion of visitor spending that is retained locally.
3. Employment Quality: to strengthen the number and quality of local jobs created and supported by tourism, including the level of pay, conditions of service and availability to all without discrimination by gender, race, disability or in other ways.
4. Social Equity: to seek a widespread and fair distribution of economic and social benefits from tourism throughout the recipient community, including improving opportunities, income and services available to the poor.
5. Visitor Fulfillment: to provide a safe, satisfying and fulfilling experience for visitors, available to all without discrimination by gender, race, disability or in other ways.
6. Local Control: to engage and empower local communities in planning and decision making about the management and future development of tourism in their area, in consultation with other stakeholders.
7. Community Well-Being: to maintain and strengthen the quality of life in local communities, including social structures and access to resources, amenities and life support systems, avoiding any form of social degradation or exploitation.
8. Cultural Richness: to respect and enhance the historic heritage, authentic culture, traditions and distinctiveness of host communities.
9. Physical Integrity: to maintain and enhance the quality of landscapes, both urban and rural, and avoid the physical and visual degradation of the environment.
10. Biological Diversity: to support the conservation of natural areas, habitats and wildlife, and minimize damage to them.
11. Resource Efficiency: to minimize the use of scarce and non-renewable resources in the development and operation of tourism facilities and services.
12. Environmental Purity: to minimize the pollution of air, water and land and the generation of waste by tourism enterprises and visitors.

Therefore, sustainable tourism development can be conceptualized as such when it provides social and economic development while considering the environment, respecting cultural

heritage and social patterns in the host region, and promoting happiness of both: local inhabitants and visitors, growth as spiritual individuals, providing inter-generation and intra-generation fairness regarding the distribution of assets. In this regard, its intrinsic conceptualization also includes a common pool of resources whose boundaries are challenging to estimate (Berkes 1998).

Although there is not a universal definition of sustainable tourism, common to all certification agencies and worldwide leaders, its operational framework has widely been through indicators (Font and Harris 2004) and all sustainable tourism certifications measure their standards through indicators. WTO (2004) states that these are considered as “an early warning system for destination managers of potential risks and signal of possible action. They serve as a key tool, providing specific measures of changes in factors most important to the sustainability of tourism in a destination.”

### **Supply chain theories**

In the analysis of supply chains, the focus has varied, from competitiveness to development goals. The conceptual differences and main theoretical ideas of some are discussed in the following section.

Supply chain approaches are fundamental to the private sector and development agendas, however, concepts used are complex and sometimes unclear (Dorst *et al.* 2010). These authors distinguish the different managerial perspectives, added value and limitations of each approach. The analysis distinguishes two main approaches: one tilted toward development goals and the other toward strategic management objectives.

The first approach to analysis of supply chains was developed by the French *filière*, a concept that rose from a systemic analysis of the agricultural sector, understanding that the production activity by itself cannot be studied alone but must include the joint analysis of those actors and products involved directly or indirectly in the transformation process (Dorst *et al.* 2010). From this approach, two main tendencies followed: those concerned with managerial decisions and creation of competitive advantages and those concerned with development goals.

The concept of supply chain management was first adopted by Oliver and Webber (1992) using a managerial point of view, in which supply chains were basically conceived as an integrating philosophy of management considering the flow of materials from inputs to outputs. Years later, the approach was developed and widely studied by Michael Porter.

Nevertheless, development goals analyzed by other scholars developed different and diverse goals, including the analysis of governance structures of chains that was first addressed by the *filière* approach. According to Dorst *et al.* (2010), the evolution of value-chain research tendencies from 1960 to the present date has evolved as presented in Figure 1.

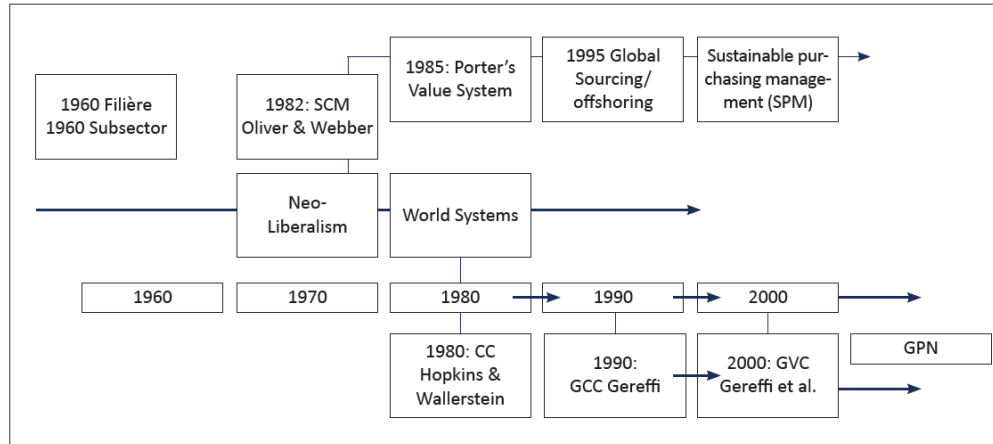

Figure 1. Evolution of the global value chain concept (Source: Dorst et al. 2010)

In the following sections, three main approaches are addressed: The French *filière* approach, the competitive value chain and its managerial approach, and the development approach. These approaches are considered the most relevant ones for comprehensive analysis relative to this project.

### The productive agriculture chain or *Filière*

As mentioned, the *Filière* approach was developed in the 1960s by the *Institut Nationale de Recherche Agronomique* (Silva 2009) and its basis was the study of vertical integration and contract farming (Raikes et al. 2000).

The word *Filière* can be translated into *network*, providing a wider range of analysis, considering the actors of the network to be dynamically involved in the development and outcomes of the agricultural sector. Much of the research done under this concept «was influenced by the needs of the colonial and post-colonial French state, since state (agricultural) development policy in former French colonies was commodity-centered and required a matching analytical framework» (Raikes et al. 2000).

This approach avoids neoclassical analysis and empirical research has focused on mapping supply chains, identifying agents and activities and understanding relationships among them. The approach aims to analyze the flows as if they are part of a system, and the analysis of the sector becomes an analysis of sectorial dynamics (Bertrand 1980).

Figure 2 explains how the chain is conceived as linked groups where inputs are transformed into outputs and, along the chain, there are interventions of political agents and transactions that influence decisions along the chain.

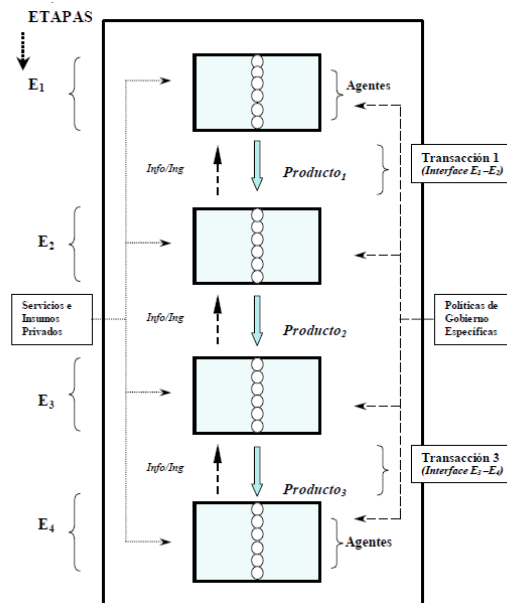

Figure 2. Diagram of the Filière approach (Source: Silva 2009)

The quantitative perspective of the *Filière* approach has focused on measuring inputs, outputs, prices and value-added along the chain. The motivation of this approach was to analyze price formation along the chain, the journey of a commodity from raw material to finished product considering all the stages and the value added generated in all of these (Berstein 1996).

According to Green and Santos (1992), the analysis within this framework should include three aspects: the technical relationships, the economic relationships and the strategic relationships. The technical relationships include the transformation processes from raw material to finished products, along with transformation processes. The analysis of technical relationships consists of identifying, programming and dividing the activities and the agents included in each phase. Within every linkage, a social component should also be considered in the analysis.

The economic relationships are directly linked to the market transactions and include both financial and commercial businesses. It is studied via price formation and price analysis as the main source of profits along the supply chain.

Finally, strategic relationships are defined as an ensemble of economic decisions that decides investment decisions in productive terms. Strategic decisions are history-bounded; therefore, a chronological analysis is crucial for strategic decision making. Though economic, institutional and technical issues integrate competitive chains, coordination and integration are guided by governance structures (Silva 2006).

Regarding governance mechanisms, actors or agents need to establish quality conventions when price is not enough for evaluating quality, which is considered one of the most important



variables when dealing with transactions. The four possible ways of establishing coordination follow (Raikes *et al.* 2000):

1. Domestic coordination: Quality uncertainties are solved by developing long-term relationships among actors or by using branding systems. Quality definition is solved internally and quality specifications become part of a region's and or /firm's brand.
2. Industrial coordination: Quality issues and definition are solved through an external party, enforcing common norms and standard for both parts of the conflict. Issues are solved by instrumental testing and certification systems whose inspection and auditing is done by a third party that certifies the fulfillment of requirements.
3. Market coordination: The only determinant of quality in this coordination is that defined by price. Prices are indicators because there are no uncertainties about quality.
4. Civic coordination: Collective commitment toward values in which the identity of the product is related to its impact in the society.

In all of these structures, there are information and power asymmetries; a change in any of the circumstances will tend to change the complete structure of the *filière*. There are appropriate institutional arrangements according to different governance structures that are discussed in section 1.2, Literature Review.

One of the main issues is the lack of established methods for analysis (Silva 2009). Some authors (Teubal 1999) (Ramos 1998) have created their own approaches and methodologies originating from the *Filière* approach. Therefore, this approach takes scientific methods and conceptual frameworks from different schools of thought (Silva, 2009) and is usually adapted to the researcher conducting the study

### **Transaction cost theory**

The use of alternative coordination mechanisms always creates costs—transaction costs; therefore, the objective of new institutional economics, founded by Coase (1937) and Williamson (1985) is to study the conditions under which firms (or supply chains) are more transaction-cost efficient than markets.

These authors understand transaction costs as all the disadvantages that transaction partners incur when carrying out an economic exchange. These can be time- or cost-related, for example, search and information costs, bargaining and contracting costs, policing costs, enforcement costs and adaptation costs. Transaction-cost economics includes the following two behavioral assumptions.

#### **1. Bounded rationality**

Agents are only partly rational—when making decisions, they are in fact emotional or irrational. According to Simon (1958), “Bounded rational agents experience limits in formulating and solving complex problems and in processing (receiving, storing, retrieving,

transmitting) information.” This term used in transaction cost theory includes not only not having access to all the information required to make a decision but also having cognitive limitations and time constraints when making a decision.

## 2. Opportunism

According to Williamson (1985):

Opportunism is self-interest-seeking with guile. This includes but is scarcely limited to blatant forms, such as lying, stealing and cheating. Opportunism more often involves subtle forms or deceit. Both active and passive forms and both ex ante and ex post types are included.

Agents make decisions in order to maximize their own benefit, whether this is detrimental or not for their partners. This assumption includes social influences, for example those of acquaintances in the same industry, in making decisions, as well as the emotional motivations.

Characteristics of transactions and characteristics of governance mechanisms determine transaction costs and the organizational solutions should be aligned with the efficiency of governance mechanisms. As for transactions characteristics, Williamson (1985) mentions three key factors that should be addressed:

1. Asset specificity: transaction-specific investments. The larger the value difference between the first-best and second-best use of the investment, the higher the degree of asset specificity. The degree of asset-specificity created bilateral dependency, the higher the asset-specific investment, the higher the dependency. There are types of asset specificity:
  - Site specificity: investment on a specific place
  - Physical specificity: physically differentiated products
  - Human asset specificity: human capital, know-how
  - Dedicated-asset specificity: investment made on a project that cannot be moved to other purposes
  - Temporal asset specificity: time
2. Uncertainty: a source of transaction costs because of the uncertainty and risk about future conditions when a transaction may take place (parametric uncertainty), as well as the uncertainty derived from the possibility of opportunistic behavior of transactions partners (behavioral uncertainty).
3. Frequency of transactions: optimal institutional arrangements depending also on how costly and frequent the transactions are between two agents.

## **Value Chains and competitive advantage**

According to Porter (1985), the competitive advantage should not be analyzed by the perspective of the company alone but from the industry it belongs to. Porter visualizes the value chain as an instrument of analysis in which competitive advantage sources are

considered. The value chain forces the company to focus on its strategic activities in order to study costs and sources of actual or potential differentiation as it strives for competitive advantage.

The value chain of a firm is embedded in a larger group of activities, called a value system. This value system indicates how suppliers interact with their own value chains and their capabilities to create competitive advantage and influence the firm and its competitiveness. The same situation occurs with buyers: they have their own value chain(s) and they interact directly with the firm. The firm's products eventually become a part of the buyer value chain so gaining and maintaining competitive advantage depends not only on the firm but in knowing where it can fit within the value system (Porter 1985).

Each firm is a set of activities that are bound together to design, produce, deliver and support its products. Porter represented the a generic value chain in Figure 3.

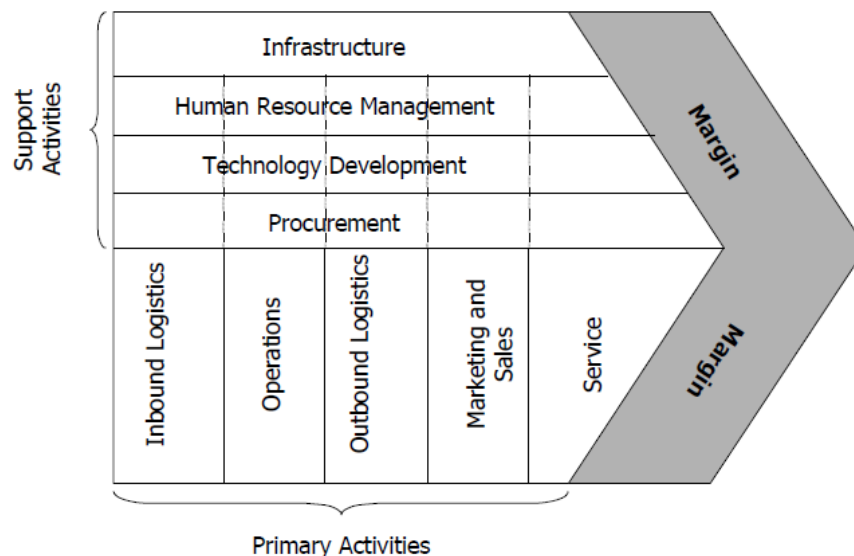

Figure 3. Generic Value Chain Activities (Source: Porter 1985)

The relevant level at which the value chain can be constructed is shaped by the activities for a particular industrial sector.

Porter's analysis of value chains emphasizes on how to gain competitive advantage and create value. The term *value* is a competitive term used to identify the quantity that buyers are willing to pay for a product (Porter 1985). The value is measured by the price and the units the company sells, thus it is a general measure of gains for the company. The competitive position would be considered from the point of view of quantity that buyers are willing to pay for a product.

The activities that create value are those that the firm develops strategically and the margins are the difference between the total value and the total cost of developing those activities. Porter (1985) divides these activities into two: primary activities and support activities. Primary activities are those directly involved in the creation and delivery of the product, as well as those related to customer support. Support activities are those that support the primary activities by providing inputs, human resources and technology. The categories of both sets of activities are listed below and the graphical representation proposed by Porter is presented in Figure 3.

#### 1. Primary Activities

- Inbound logistics: all activities related to the receipt, storage and scattering of product inputs, as well as material management, inventory control, vehicle programming and return to suppliers
- Operations: activities associated with input transformation, such as packing, assembling, equipment maintenance or installation
- Outbound logistics: activities associated with the collection, storage and physical distribution of the product to the buyers, including the storage of finished products, materials management, delivery vehicles operations, requests procedures and programming
- Marketing and sales: activities associated with the provision of marketing strategies so that buyers are influenced by the firm to buy the product, such as promotions, quotes, delivery channels and price strategies
- Service: activities related to services that support or enhance the value of the product, such as installation, repair, training and product replacement and adjustment

#### 2. Support Activities

- Procurement: the acquisition of inputs, including raw materials as well as other inputs for equipment, laboratories, offices and buildings. Although procurement activities are considered primary ones, they are present in every step, including the support activities. Appropriate procurement can affect total costs and value of the firm depending on the quality of the inputs and interaction with suppliers.
- Technology development: use of technology in each activity. It can either be in terms of know-how and procedures or the use of technology equipment. All of these activities help raise the value of the firm across all of its primary activities.
- Human resource management: activities involved in the search, hiring, training, development and compensation off all types of personnel/staff. Human resource management occurs at all levels of organization and therefore it requires support activities at all levels.

- Infrastructure: management, planning, finance, accounting and legal issues. This is the only activity that supports the chain as a whole and not as individual activities.

For analyzing value chains, Porter states that activities should not be analyzed independently but as interdependent. Links among activities are the relation between the performance of one activity, and the costs and performance of another. These links can generate competitive advantage from optimization and coordination. Coordinating activities by linkages usually reduces costs and increases differentiation. Gaining competitive advantages from linkage exploitation requires information among links that allows for optimization through coordination.

The links among value chains exist not only inside a firm but also among supply chains of suppliers, which are referred to as vertical integration. Joint collaboration between these two links may generate competitive advantage although it requires active information flows, which are easier to manage within a firm. On the other hand, buyers also have and manage value chains; the product of a firm is also the input for the buyer's value chain.

The competitive overview of the company can be analyzed through the overview of the sector in which the firm operates, the degree of integration of the chain and the geographic and industrial overviews. Evaluating the competitive advantages at different levels provides the firm with a better understanding as well as better opportunities for developing a wider range of activities internally or in coordination with chains that serve other geographical areas, industrial sectors, or other sectors.

Value chain analysis is a fundamental tool for the analysis and diagnosis of competitive advantage of firms and ways of creating and maintaining it. Nonetheless, value chains can also play an important role in the design of organizational structures. Organizing the activities of the firm into groups (departments) and integrating them through coordination are systematic ways for analysis provided by the value chain approach.

### **Development approach of supply chains**

The analysis of productive chains in Latin America has evolved from a development perspective, especially in the agricultural sector; to a more industry-oriented perspective. Globalization has promoted the development of two types of chains: those conducted toward buyers and those conducted toward producers (Gereffi 2001). Productive chains conducted towards of the producer are those mainly conducted by large companies (transnational companies) and their upward and downward linkages. However, productive chains conducted toward the buyer are those in which large brand holders and retailers pivot the decentralization of activities along the chain, and the decentralization is done mainly in Third World countries (Gereffi 2001).

This approach has evolved into the analysis of global value chains or global commodity chains, which allows specifying more precisely, in space and time, the organizational features and changes in the transactional production system underlying the competitive strategies of firms and states (Gereffi and Korzeniewicz 1994). According to Gereffi and Fernandez-Stark (2011), the global value chain methodology studies:

1. an input-output structure: description of the process of transforming raw materials into finished products,
2. a geographical consideration,
3. governance structure: explains by whom and how the value chain is controlled,
4. institutional context in which the value chain is embedded

The input-output structure involves goods and/or services and their supporting industries. The approach also identifies the main activities and segments and their relationships. Its analysis includes the evolution of the industry and its trends (Gereffi and Fernandez-Stark 2011). It involves identifying and mapping the main actors of the chain as well as their supporting industries and the relationships they have, which are dynamic.

With respect to the geographical scope, global value chains operate locally, nationally, regionally and globally, but the identification of the lead firm is the first step in the study of the regional scope. Geographical considerations include improvement of transportation and communications driven by demand in each link in the chain (Gereffi and Fernandez-Stark 2011).

When considering governance structure, information asymmetries have their impacts on price determinations between sellers and buyers (Granovetter 2005), and therefore in different governance mechanisms.

As mentioned, transaction costs are the basis for decisions of supply chain partners when creating alliances with their suppliers (Hitt 2012). The process of agreement among actors can generate frictions and higher transaction costs as a result of asymmetries in information access, bounded rationality and opportunistic behavior among actors (Williamson 1979).

An extension of transaction-cost theory has also been applied in supply chain analysis; transaction costs define the relationships created among supply chains. Gereffi *et al.* (2005) suggest a governance typology in global value chains, bounded to the structural transaction costs theory proposed by (Williamson 1991). The governance typology is the following:

1. Market structures: These are the lowest level of cooperation between actors in which the buying-selling rules are clear and commonly understood. Transactions are as simple as possible and there is no need for a structure to make any kind of transfer: the transactions are made in markets. These have low transaction costs; therefore, actors do not tend to deal with any kind of arrangements.

2. Hierarchy: Product and transaction requirements are very specific and therefore enterprises and supply chains tend to integrate vertically. Generally, there are larger controls over production and commercialization due to asset specificity.
3. Hybrids structures: These are structures that are not located in any of the extremes presented above. Differences in asset specificity, products characteristics and transaction complexity is what makes these structures hybrid (Williamson 1991).

Gereffi *et al.* (2005) classify these hybrid structures in the following organizational structures.

1. Modular value chains: The ability of codifying product specification is less complex than the products themselves. Product specifications are codified from a common understanding between buyers and suppliers, so that they only have to work through codified products instead of analyzing the product each time in each transaction, which reduces transaction costs.
2. Relational value chains: These take place when specifications of a product cannot be codified, transactions are complicated and the capacities of the supplier are high. In these cases, information flows and constant communication among partners is needed and therefore changes in partners can demand high costs.
3. Captive value chains. These occur when the ability to codify and product complexity specifications are high but the capacities from the supplier are low. These result in changing prices and the buyer is the most important actor in decision-making processes.

Figure 4 illustrates how the five types of chains differ from each other with respect to power asymmetries and explicit coordination leading to different governance mechanisms.

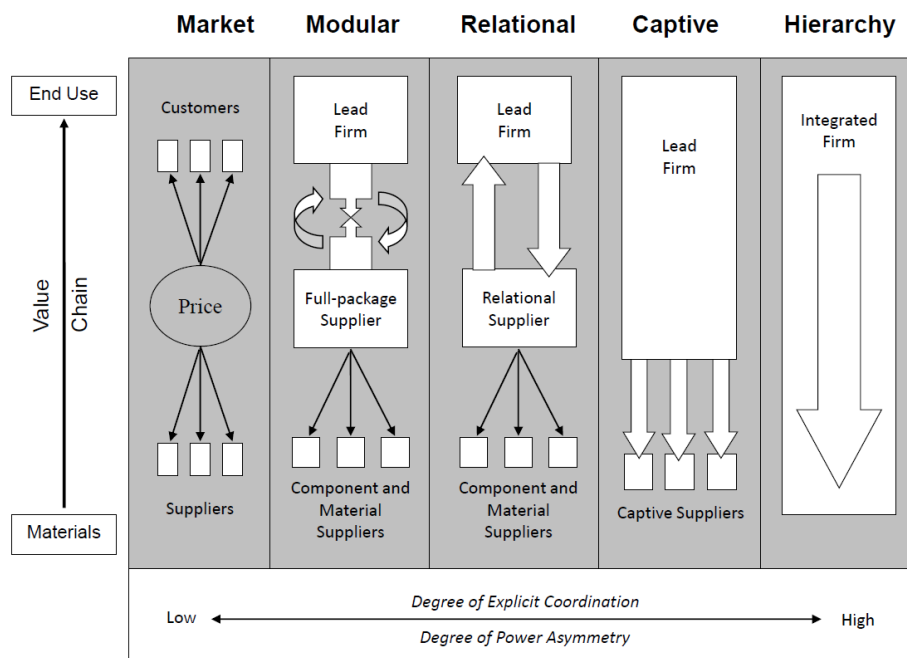

Figure 4. Five global value chain governance structures (Source: Gereffi *et al.* 2005)

Finally, institutional arrangements define how international, national and regional policies shape globalization in each step because chains are embedded in a social economic and institutional framework (Gereffi and Fernandez-Stark 2011), and therefore the social and cultural context should be included in analysis of supply chains.

## **2.2 Literature review**

The most important results and findings from research projects on topics such as sustainability, smallholder organization, governance structures in agriculture-related supply chains and supply chain management linked to tourism, fresh products and small farmers are considered in the following literature review.

### **Sustainable development**

Sustainability has been a key consideration in the development agenda and therefore political decisions have begun to consider sustainability as an important aspect of development. The commission responsible for Our Common Future (WCED 1987) identified critical objectives of sustainability and provided some insights on the conditions needed for sustainable development.

The critical objectives identified are reviving and changing the quality of growth; meeting essential needs for jobs, food, energy, water and sanitation; ensuring a sustainable level of population, conserving; and enhancing the resource base, reorienting technology, managing risk and merging environmental and economics in decision making.

The critical conditions established by the commission for reaching those objectives are these:

1. a political system that secures citizen participation in decision making
2. an economic system that provides solutions for the tensions arising from disharmonious development
3. a productive system that respects the ecological base for development
4. a technological and international system that fosters sustainable patterns in trade and finance
5. an administrative system that has the capacity for self-correction

Although there is some progress in terms of consciousness and legal enforcement regarding social and environmental preservation, the Millennium Goals for Development (MGD) listed below (United Nations 2000) are sometimes criticized by international NGOs because of the lack of specific, binding commitments that arose from international meetings (Elliot 2013).



1. To eradicate extreme poverty and hunger
2. To achieve universal primary education
3. To promote gender equality and empower women
4. To reduce mortality
5. To improve maternal health
6. To combat HIV/malaria and other diseases
7. To ensure environmental sustainability
8. To develop a global partnership for development

Although sustainability and sustainable actions toward development are intertwined, the most common conception of sustainable development includes three dimensions: economic, environmental and social. The economic aspects of sustainable development include services, household needs, industrial and agricultural growth and efficient use of labor. The social aspect includes equity, participation, empowerment, social mobility and cultural preservation. Finally, environmental issues include biodiversity, natural resources, carrying capacity, ecosystem integrity and clear air and water (World Bank 2001).

Although the three dimensions of sustainable development have been independently analyzed by academics, there is agreement that the interdependence and dynamics of these aspects cannot be neglected. The interactions of environmental, economic and social aspects must be addressed from a holistic perspective. In defining sustainability, Liu (2003) mentions that the concept must be a dynamic one that includes the process of changes and fairness of benefits.

In spite of the increasing political importance of sustainable development, the detriment in equity since the *Brundtland* Report, according to Sneddon *et al.* (2006) has its “linkages with ineffective institutions and general lack of political will on the part of governments and citizens at multiple scales.” Political agendas often mention and approach sustainable topics, nonetheless they are not efficiently enforced. Despite this situation, the research agenda has more actively proposed and empirically analyzed the importance of sustainable development practices, recognizing the interdependence of the three pillars of sustainable development and political challenges (Elliot 2013), including sustainable tourism development.

Sneddon *et al.* (2006) analyze how the concept and implementation of sustainable development has evolved since the Brundtland Report based on publications related to this topic. Interdependence of sustainability affairs calls for multidisciplinary approaches for the study of sustainable development; however, this is not enough for sustainability analysis: a reconstruction of environmental political and governance institutions according to their fundamental norms is mandatory (Sneddon *et al.* 2006).

Poverty is one of the main constraints to achieving sustainable development; it is related to higher birth rates as well as to higher environmental degradation from efforts to supply their own needs (Pinstrup-Andersen *et al.* [eds.] 2001). This is why scholars have developed

tourism-related efforts in pro-poor strategies, recognizing the possibilities tourism brings to the development scene (Redford *et al.*, 2013, Truong *et al.* 2014 and Winters *et al.* 2013).

Poverty alleviation is not an end in itself: achieving sustainable development generates extended benefits to all actors; increasing competitiveness along the chain brings benefits for all directly linked actors and positive externalities for regional development purposes.

### **Sustainable tourism**

Tourism is one of the most important industries in the world. Its rapid growth and expansion has particularly become important in developing countries, where growth rates are higher than in developed countries and worldwide (Ashley *et al.* 2007, Neto 2002). Many nongovernmental organizations (NGOs) and development institutions such as the World Bank, Food and Agriculture Organization (FAO) of the United Nations, as well as local organizations, perceive tourism as a possible tool for lowering poverty and unemployment rates in rural communities, which have in general, lower economic indexes (Olinto *et al.* 2013).

Tourism affects not only those who participate directly in tourism activities but also indirect jobs through its supply chain. According to Ashley *et al.* (2007), the intersectorial impact of tourism accounts for 60 to 70% extra of the direct impacts of tourism. Given this reality, it is important for the tourism industry to continue its development through a fair distribution of benefits.

Nonetheless, tourism's rapid growth has sometimes developed in an uncontrolled degradation of natural resources in many regions, as well as impoverishment of locals through expropriation of land tenure and an unfair distribution of benefits (Sharpley 2000). In Costa Rica, this rapid growth had led to environmental problems, especially around the most popular parks and beaches (Rivera and Leon 2005), which can be contradictory given that natural resources are the main attraction for most tourists that visit developing regions.

Given this situation, national and international bodies have developed an increasing interest and have created a series of certifications for sustainable tourism, aiming for a development that encompasses not only economic benefits but also its fair distribution and social and environmental concerns, according to the abovementioned discussion on sustainable development.

An appropriate acknowledgement of the importance of the social and cultural norms of the host community is one of the most important factors to consider when referring to tourism's sustainability (Telfer and Wall 1996). If tourism can enhance the standards of living, the analysis of further backward linkages needs to be considered by those who develop indicators; if not taken into account, residents may lose more than they gain from tourism development. For the intricate relationships within a host society, Gunn (1994) proposed that

tourism require multidisciplinary research, including the following key disciplines: marketing, behavior, business history, geography, anthropology and political science.

Tourism provides the following benefits that can originate from a good policy (WTO 2004):

1. Tourism is consumed at the point of production, providing direct and indirect income.
2. Rural areas, where there are higher rates of poverty, are often rich in capital assets that create high value for these regions.
3. Tourism is labor-intensive, which creates higher opportunities for women and young people in the development of new skills.
4. Tourism promotes the creation of small and micro entrepreneurs.
5. Tourism supports the construction of public infrastructure and the conservation of natural and cultural heritage, providing a sense of ownership in the communities.

All of these potential benefits can be either prompted or diminished. Their fate depends on structural policies, the extension of those benefits to the host communities, structural arrangement and managerial skills.

Fairness in distribution is affected by how strong linkages to main economic activities are, so that benefits from the tourism industry can also provide benefits to related productive activities. A successful strategy for achieving a fair distribution of benefits would have higher positive externalities when products are locally produced. Evidence from different parts of the world suggest that when products are mostly imported, efforts on policies for tourism development have lower impacts on local or regional populations (UNEP 2013).

Many tourism agencies, national and international institutions, and NGOs have created a set of indicators to aim for sustainable tourism development through tourism certification systems. Most certification agencies have reached a common understanding about the importance of the following aspects that derive from the concept of sustainable development itself: environmental development, economic development and sociocultural development. The balance between these components as well as participation of all stakeholders in building a consensus of local development are the basis for a successful strategy.

While defining indicators for sustainable tourism, the WTO (2004) suggests that all involved stakeholders participate in the definition of indicators as well as in the later measurement of these indicators. The joint participation of various stakeholders creates the opportunity to visualize all of the possible benefits and problems derived from tourism for a wide arrangement on inter-linked actors.

The Global Sustainable Tourism Council (GSTC) is an multi-stakeholder organization of a coalition of partners under the umbrella of the United Nations (UN) whose objective is to promote and develop, through knowledge and education, sustainable tourism (GSTC 2014,

United Nations 2012). The GSTC was created in 2010 and has developed indexes for different certification systems, *i.e.*, criteria for hotels and tour operators and criteria for destinations.

For this research project, interest would focus on criteria for destinations and the holistic perception and analysis this type of certification suggests. Since sustainability includes incorporation of all stakeholders in the supply chain, focusing only on hotels or tour operations would be fruitless.

In November 2013, GSTC launched the general principles for destination certification (GSTC 2013), which includes four pillars: sustainability management, social and economic, cultural and environmental. These pillars are arranged in four main sections.

1. Section A: Demonstrate sustainable tourism management
2. Section B: Maximize economic benefits to the host community and minimize negative impact
3. Section C: Maximize benefits to communities, visitors and culture and minimize negative impacts
4. Section D: Maximize benefits to the environment and minimize negative impacts

All of these sections include a series of indicators that define sustainable development of tourism from different points of view under a holistic concept of sustainability. It is important to address the intrinsic nonlinear relationships among actors of the tourism supply chain, and therefore any approach to measuring or addressing sustainability has to be able to propose strategies for solidifying sustainable development in practical terms, knowing there is no one-way perspective but rather a series of perspectives from different actors.

In Costa Rica, the development of sustainable practices for tourism has been conducted by the Certification for Sustainable Tourism Program (CST), which is managed by the Costa Rica Tourism Institute (ICT), a national initiative to promote sustainable tourism through incentives. The CST is carried out by third-party audits that categorize and certify tourism companies through the following aspects (CST 2013):

1. physical-biological parameters
2. infrastructure and services
3. service management
4. external client
5. socioeconomic environment.

CST is an important initiative in the country; nonetheless, it certifies hotels, restaurants and tour operators but does not consider a region as a whole; there are no regional certifications and therefore no holistic perspective on sustainability of a destination. Backward linkages are not so predominantly considered, which is vital for a regional holistic approach of sustainability. The GSTC concept of a sustainable destination is aligned with the United

Nations Millennium Goals, including poverty alleviation, gender equality, environmental sustainability and climate change, and though this GSTC for destinations, maximum levels of cooperation among actors are needed for a local promotion of better development standards (GSTC 2013).

The analysis of sustainability within a region should not include only backward and forward linkages but also the analysis of horizontal ones in the intention of analyzing common action among actors of the same link of the supply chain for improving managerial skills and market access along the chains. In this regard, research from Nicaragua on community-based tourism (CBT) has proven that companies with higher relative income are those that diversify their hard core businesses, including restaurants, catering services and tour operators (Zapata *et al.* 2011). Therefore, promotion on horizontal linkage that may have a positive effect on income seems a good possibility for addressing more linkage creation among tourism-related activities, as well as backward linkages.

### **Sustainable supply chain management**

Through sustainable supply chain management, the concept of competitiveness has evolved. A company can no longer be considered competitive if its supply chains are not. For a supply chain to be competitive, all of its actors and the relationships among them must be competitive as well.

Though the terms have usually been used indiscriminately, Stoian and Gotret (2011) have characterized the differences between supply chains and value chains (Table 2)—these differences are the determinants of competitiveness.

Table 2. Supply chain and value chain definitions

Criteria	Supply chain	Value chain
Purpose	Competitiveness of actors	System competitiveness and long-term vision
Orientation	Guided by the supply	Guided by the demand
Objective	Maximize earnings and minimize costs without considering any aspects other than economic ones	Add value through productivity, quality, traceability and differentiation
Vision	Commercial relationships and supply of products in a short or medium term	Commercial relationships and supply of products in the medium or long term, with win-win strategies
Organizational structure	Independent actors	Interdependent actors
Type of relationships	Low level of cooperation and trust among actors	Medium to high level of cooperation and trust; clear and transparent definition of norms
Information flows	Low and limited to commercial transactions	Relevant and timely for effective development of actors' relationships

*Source: Bourgeois and Herrera (1999), Stoian and Gotret (2011)*

According to Pagell and Wu (2009), a sustainable supply chain (or value chain) is one that has good standards on traditional measures as well as in the other dimensions included in the definition of sustainable development: social and environmental. Seuring and Müller (2008) define sustainable supply chain management as the material, information and capital flows as well as cooperation among companies while achieving goals in the three dimensions of sustainable development: economic, social and environmental, client`s and stakeholder`s requirements.

For sustainable supply chain management and the previously mentioned topics on supply chain management and value chains, two predominant issues can be highlighted: sustainability includes managerial decisions based on economic, environmental and social criteria and it also implies the need for collaboration among actors of the supply chain.

When dealing with smallholders, understanding their characterization and reasons for interaction would be the key in determining strategies for promoting sustainable linkages, notwithstanding that behavior of smallholders is dependent on risk aversion and, largely, on cultural factors (Debertin 2012). Agricultural production is a very risky activity and

agricultural producers are motivated not only by economic incentives but also by those for stability.

Therefore, effective supply chain management is particularly important when dealing with fresh products (Boehlje *et al.* 1995) because fresh products need fast and effective supply chain management so they do not perish along the supply chain, as well as efficient postharvest procedures that do not diminish quality.

Integration of supply chains, as well as the adoption of sustainable practices, has proven to increase performance goals in the manufacturing industry (Zhu and Sarkis 2004) and in the food industry (Vasileiou and Morris 2006, Schiefer 2002, Berno 2006). Nonetheless, management faces problems when integrating the last links of the chain (Stoian and Gotret 2011), which in this case are the agricultural ones.

Through an adequate supply chain management, a totally integrated sustainable supply chain can be achieved, according to Seuring and Müller (2008) when there is sufficient communication among actors so that it is guided by the [tourist] demand. In this case, production decisions should be guided by the tourists' needs and not by arbitrary smallholders' harvest decisions, which are based on previous knowledge of the crop or input access (Debertin 2012).

## Organization of smallholders

The definition of SMFs may vary according to conditions of the country or region, therefore, according to Costa Rican legislation, and MAG, Table 3 classifies what is understood as small and medium producers.

Table 3. Small and medium farmer classification in Costa Rica

Agricultural farms for agricultural production	Small producers (ha)	Medium producers (ha)
Vegetables and legumes group 1: potatoes, onions, tomatoes, chayote, chili and hot chili	$\leq 1$	$> 1 = 5$
Vegetables and legumes group 2: lettuce, cabbage, carrot, cucumber; sweet beets, broccoli, cauliflower, celery, squash, pumpkin, cilantro, radish, field mustard, <i>arracache</i> , cebollino, mushrooms, ginger, eggplant, basil, oregano, thyme, garlic and other vegetables and legumes	$\leq 1$	$> 1 = 3$
Roots and tubers: cassava, tiquizque, malanga, sweet potatoes, yam and taro	$\leq 5$	$> 5 = 15$
Fruits group 1: pineapple, banana, orange, melon, watermelon and mango	$\leq 25$	$> 25 = 100$
Fruits group 2: papaya and plantain	$\leq 15$	$> 15 = 35$
Fruits group 3: lemon, tangerine and other citrus, coconut, apple, plums, avocado, strawberries, blackberries, rambutan, star fruit, guava, passion fruit, figs, tamarind, malay apple, pitahaya, and others	$\leq 5$	$> 5 = 10$
Cacao coffee and spices: coffee, cacao, vanilla, pepper, cinnamon	$\leq 15$	$> 15 = 50$
Seeds and diverse fruits: aloe vera, mint, chamomile	$\leq 1$	$> 1 = 3$

*Source. Sistema de Registro del Ministerio de Agricultura y Ganadería (2013)*

Many governments in developing countries have dismantled marketing boards that looked after smallholders' interests (Hellin *et al.* 2009); in Costa Rica's case, the system has shifted from local development toward mass production for international markets with high value-added products, such as pineapple, mango, citric juices and tubers, mainly produced by international companies (Fernández-Alvarado and Granados-Carvajal 2000). Therefore, small and medium farmers struggle to access high value-added markets.

Pushing and promoting high value-added products is considered one of the most important strategies that the Costa Rican Ministry of Agriculture should follow to gain a competitive advantage in international markets (Arias 2005). However, smallholders who turn from scratch crops toward higher-value crops face multiple changes in markets, from both demand and supply sides since high-value crops are linked to higher urbanization rates, higher



exposure to international competition and economic growth of consumers. Therefore, overall standards for high-value products are also higher.

As requirements increase, transaction costs increase as well, and guided by new institutional economic theory on transaction costs, hybrid arrangements tend to gain importance for the benefit of both sellers and buyers along the supply chain.

To meet the sector's needs, a comprehensive collective action of actors guided by mutual communication is essential for establishing potential benefits. Nonetheless, collective action will only take place if there is common recognition of mutual needs and goals.

There is increasing interest in creating joint actions to include smallholders in development strategies. This is evident in many research projects that, from different points of view, try to include small agricultural producers in development patterns, as well as agricultural small and medium enterprises (SMEs), which play a crucial role for appropriate income distribution—critical when considering sustainable development in sustainable destinations. The results of such research projects are presented on the following pages.

Modern food systems are close to being monopsony markets (Pingali *et al.* 2005). Although the number of potential suppliers (small farmers) is large, Haynes (2000) specifies the transaction costs that arise from working with large numbers of smallholders:

1. the bureaucratic costs associated with management, coordination, processing and marketing,
2. the opportunity cost of time used to communicate and coordinate with small farmers,
3. the costs of establishing and monitoring long-term contracts,
4. the screening costs linked to uncertainties about the reliability of suppliers and product quality,
5. the transfer costs of legal or physical constraints.

Torres and Momsen (2004) carried out a literature review in which they identified factors that restrict smallholder participation in linkage generation for tourism supply chains. Restricting factors are divided into supply (production related), demand and market presented in Table 4.

On the other hand, some authors (UNEP 2011, Bohdanowicz *et al.* 2001, CREST 2012) have focused on factors for success of those linkages between agriculture and tourism. They have also divided these enabling factors to those related to the small farmers (supply side), their characteristics and the interests and to those from the demand side (tourists' needs).

The main enabling factors from the supply side are these:

1. stakeholders participating in the strategy design
2. high potential for SMEs, since size considered to be one of the most important factors in generating multiplying effects
3. need for regulations toward compliance
4. local hiring
5. partnerships for accessing sustainable certifications (because of common interest, benefits and shared costs)
6. written contracts with producers (formal)

In contrast, enabling factors from the demand side include:

1. willingness to pay for more environmental practices (general tourism services)
2. type of tourists (demand for environmentally friendly practices); highest demand for more sustainable practices from those who travel the most
3. authenticity of the experience (place)

Table 4. Empirical restricting factors for creation of agriculture and tourism linkage.

<b>Supply (production related)</b>	<b>Demand Side</b>	<b>Market</b>
Lack of partnership development	Foreign-owned, large and high-end hotel preference for processed and imported foods	Failure to promote local foods
Lack of sufficient, consistent and guaranteed quantity of locally produced food	Immature tourism industry preference for imported and internally supplied foods	Poor/inadequate transportation, storage, processing and marketing infrastructure
Inadequate quality of local production	Certain types of tourists' ( <i>e.g.</i> mass and foreign) preferences for imported and/or home-country foods	Mistrust and lack of communication/information exchange between farmers, suppliers and tourism industry
High prices of locally produced foods	Tourist and chef mistrust of local food owing to sanitation, hygiene and health concerns	Entrenched monopoly marketing networks that prevent local farmer access
Local farming systems' small economies of scale	Preference of foreign or internationally trained chef for imported foods	Corrupt local marketing networks that limit local producer access
Poor growing conditions		Bureaucratic obstacles and informal nature of local farming operations
Nature of existing local farming systems		
Lack of capital, investment and credit		
Technological restrictions		
Farm labor deficit attributable to competition with tourism sector		
Smallholders cannot comply with quality and control requirements		

*Source Torres and Momsen (2004) with reference to Andreatta (1998); Ashley and Jones (2001); Bélisle, Tourism and Food Production in the Carribean (1983); Bélisle (1984a); Bélisle (1984b); Bowen, Cox and Fox (1991); Carter (1987); Doxey and Associates (1971); ECE/FAO (1982); Goffe (1975); Gomes (1993); Gooding (1971); McElroy and Albuquerque (1990); Miller (1985); Milne (1992); Momsen (1972); Momsen, Report on Vegetable Production and the Tourist Industry in Motserrat (1973); Momsen (1986); Momsen (1998), Momsen (2002); Monk and Alexander (1986); O'Ferral (1991); Pattullo (1996); Pizam and Sussmann (1995); Saville (2001); Sharkey and Momsen (1995); Shaw and Williams (1994); Telfer, D (1996); Maldonado (1997); Torres, R (2000); Turner and Ash (1975); Tyrakowski (1986); USAID (1984); Weaver (1991)*

Reardon and Berdegué (2002) studied the supermarket sector in several countries in Latin America, including Costa Rica. Findings suggest that quality standards, safety standards, packing, volumes, consistency and payment practices are still important challenges for farmers of the region. Rules established by retailers are changing the farmers' conditions along the agri-food supply chain. Opportunities provided by supermarkets for farmers require a redesign of development strategies for small enterprises.

Accordingly, Reardon and Berdegué (2002) proposed that development agencies need to take into account that farmers have to gear up to compete in the new markets guided by supermarkets because local markets with lower standards are disappearing and the distance between international standards and local markets are also diminishing.

Van-der-Straaten (2002) analyzed three European case studies of community improvement through tourism and concluded that appropriate marketing is a key to successful strategies. The author also suggests that governmental support to farmers should be conditioned on environmental performance. Finally, he concludes that "the concept of sustainable tourism can only increase the potential of regions which are more or less favorably located," especially if guided by a regional, rather than a top-down approach.

As mentioned, the necessity for involvement of stakeholders seems mandatory. According to WTO (2004), key factors in obtaining constructive local or regional participation are the following:

1. early contact with local groups
2. provision of forums, meetings and discussions where all interested stakeholders can identify interests and concerns
3. provision of feedback in a clear form (showing participants that their opinions have been taken into account)
4. ongoing involvement of key players throughout the process (openness and transparency)

De Janvry and Sadoulet (2005) also studied the factors of success from inclusion of smallholders in development of high-value crops. Factors of success are sectorial policies, entrepreneurial competence, coordination among stakeholders and prior institutional development and technical upgrading. If these factors are available, smallholders are more likely to associate with high-value markets, creating the following positive impacts among smallholders:

1. access to improved technologies
2. understanding market requirements
3. technical and agronomic learning
4. access to technical assistance
5. access to inputs and finance

6. long-term agricultural income
7. business management skills

On this same topic Reardon *et al.* (2005) studied the linkages between small farmers and wholesalers in Latin America in supermarket supply chains. Decisions to participate in the supply chain were analyzed from two perspectives: the supply (wholesalers and farmers) and the demand (retailer). Capacity, costs, managerial skills, quality of the product and threshold firm size are the main factors considered by retailers. On the other side, farmers and wholesalers take into account the following variables when they consider entering a supermarket supply chain: the price premium, the cost of technological change and the cost of “doing business” with supermarkets as well as the market risk when dealing with supermarkets.

Regardless of the sourcing of retailers, whether direct or through wholesalers, there is a general tendency to prefer sourcing from more capitalized farmers who can meet the requirements of the chain: better organizational and technical capabilities as well as adequate institutional capital (Reardon *et al.* 2005).

The inclusion of smallholders in chains has certainly created room for discussion on the implications and requirements for small farmers. Pingali *et al.* (2005) suggest that smallholders face two main difficulties in adapting to food systems today; their ability to commercialize from production systems that are usually semisubsistence and the second refers to the crop of choice.

Fleischer and Tchetchik (2005) studied cases of agricultural and tourism working farms. They found that visitors do not value working farms but that a company producing agricultural goods and having tourism services uses their factors more efficiently than those not managed by non-farmers. From the tourists’ perspective, they are willing to pay higher prices in places that are rich in tourist attractions and firms that locate in these places have higher productivity levels.

Identifying benefits from coordination with small farmers has also been another discussed topic. Advantages for coordinating supply chains are commonly related to better prices, higher quality and safety standards, plus reduction of costs due to higher efficiency and reduction of losses (Van-der-Meer 2006). Fresh product losses can be higher due to uncoordinated or poorly coordinated supply chains.

Gulati *et al.* (2005) identified some factors or conditions that limit smallholder participation in high value-added chains; and these are mainly connected to their farmers’ characteristics. Smallholders cannot comply with quality and control requirements, cannot provide standardized products and lack market access due to lack of information and familiarity with the system.

Some of the most important constraints when working with small farmers are the lack of market knowledge, lack of appropriate technologies or modern inputs, and access to capital (to

upgrade production). Scale, low quality and heterogeneity of products are also some of the problems small farmers face when included in supply chains; they would rarely be included in supply chains if not supported by traders and processors (Van-der-Meer 2006). Mutual trust between farmers and enterprises would reduce risks and therefore costs; nonetheless, organization of farmers and effective leadership are crucial factors for overcoming weaknesses (Van-der-Meer 2006).

Henson *et al.* (2008) analyzed the possibilities and benefits of African smallholders' participation in high-value markets, given that their inclusion is essential for development goals. They concluded that there is a lack of consensus in determining success of interventions, but they could identify positive and negative effects of contract farming along the supply chain.

Producers now often supply sophisticated and long value chains (Hellin *et al.* 2009). Research in Mesoamerica suggests that evidence of benefits from farmer organization is more evident in the vegetable sector, where there are higher transaction costs, but it is very rare for smallholders to self-organize (Hellin *et al.* 2009).

Kannan *et al.* (2009) conducted a study in the battery industry in India regarding third-party vendors and their selection process. They identified these as the defining criteria when considering vendor selection: quality, delivery, reverse logistic costs, rejection rate and technical/engineering capability, inability to meet future requirements, and willingness and attitude.

Neither the level nor the distribution of income will be improved for the poor unless they have improved access to assets such as land and education, which can make their primary asset, labor, more productive during the growth process (Norton *et al.* 2010).

Given the importance of linkage creation, Zapata *et al.* (2011) mention the possible benefits derived from developing win-win situations:

1. gain legitimacy, training and credit by developing linkages with public authorities
2. attract further visitors and promote market access by developing linkages with international tour operators
3. improve competitiveness of the local market by creating linkages with local production and public-private partnerships

Organizational arrangements vary, but they comply with actors' arrangements to reduce their transaction costs in the process of making profitable negotiations. Actors develop formal or informal institutional arrangements to reduce transaction costs. Social networks and linkage creation were not considered to be determinants of economic decisions in traditional economics, but their key role in decision making have made their analysis transcendental in understanding why actors tend to develop different institutional arrangements in different circumstances.

Granovetter (2005) analyzes the impact of social structures in economic decision making procedures. He mentions four core principles for social networking:

1. Norms and network density: A denser network provides better defined and easier-to-enforce norms.
2. The strength of weak ties: Individuals are linked to larger networks by their weakest links rather than their closest ones: new and important information is better distributed through weak ties rather than the closest ones.
3. Structural holes: Benefits arise from belonging to different networks that are apart from each other, because information flows would be acquired from both networks.
4. The interpretation of economic and not economic decisions: This last principle becomes particularly important when dealing with smallholders, whose decisions are not merely dependent on economic aspects; also, non-economic decisions will affect economic ones. A recognition of the interdependent social and economic terms is needed for an analysis.

In agriculture and tourism, such as in other industries, policy measures always face free-rider issues in which individuals can obtain benefits without paying a fair share for them, necessitating government or institutional intervention (Norton *et al.* 2010). As in this case, where controlling systems are not developed—because there is not a value chain—loyalty measures seem to be a more reliable incentive for promoting common interest than dealing with free-rider behavior. Loyalty measures function because these according to Granovetter (2005), create “attempts to elicit cooperation from workers deriving not only from incentives but also from identification with the firm or with some set of individuals that encourages high standards and productivity.”

Some perspectives on this matter propose that an ideal system would be hybrid—for example, between the two extremes in which there are some parameters to comply with as well as some other aspects directed by loyalty measures. Quality, quantity and other logistics criteria need to be guarded by strict controlled systems by the focal company, although these standards need to be specified by collective action between both groups (smallholders and buyers) so that standards are realistic for both actors.

In this particular case, products have complexity specifications and although not yet analyzed, smallholders have traditionally had low capacities regarding product specifications and overall compliance with market specifications.

Networking is defined as a structure of more than two actors that pursues repeated, enduring exchange relationships with one another, but at the same time, lack a legitimate organizational authority to arbitrate disputes that may arise (Podolny and Page 1998).

In terms of analysis of collective action Markelova *et al.* (2007) identify three broad factors as important:

1. Characteristics of the user group: shared norms and codes of conduct, appropriate leadership and the adapting of proper organizational structures are some of the most important factors in considering collective action. Past experiences of working together successfully may also influence possibilities of collective action (Agrawal 2001), which can be a result of shared and diminished risk among well-known partners.
2. Institutional arrangements: organizational structures are critical in shaping collective action. Simple and easily monitored rules are the most appropriate when developing collective action strategies. Akwabi-Ameyaw (1997) found that in government-initiated cooperatives, participants did not understand the rules and did not identify with the organization that imposed them.
3. External environment: studies on collective action have identified relationships to the market and the state to be important.

A community agency to help the community meet its needs, networks, associations and related channels of communication is essential to establishing community efforts (Matarrita-Cascante *et al.* 2010). Efforts oriented toward sustainable development are better oriented when the community has full understanding of local resources and the capacity to manage them.

Although a community agency does not necessarily fulfill all sustainable development requirements, it surely tends to include the community in its own development, which can be considered an important element of sustainable development (Matarrita-Cascante *et al.* 2010).

For tourism promotion, especially in natural destinations like Costa Rica, sustainable development, environmental preservation, cultural richness and economic viability are mandatory, and backward linkages with (agricultural) host communities can provide overall well-being. Costa Rica's tourism marketing strategies have since the 1990s been guided by the promotion of natural environments, but tourist validation is necessary for a successful development of the industry.

In terms of the important factors considered for vendor selection and partnership development, most authors consider, either from a demand or from a supply perspective, the following:

1. Attributes of the product, such as quality (Kannan *et al.* 2009, Reardon, *et al.* 2005, Gulati *et al.* 2005, Torres and Momsen 2004) and costs (Van-der-Meer 2006, de Janvry and Sadoulet 2005).
2. Attributes of the supplier such as legal compliance, technical and managerial skills (Reardon, *et al.* 2005), education (Norton *et al.* 2010) and trust in their performance (Zapata *et al.* 2011).

Other authors consider policy implication as determinant for partnership development, especially sectorial policies (de Janvry and Sadoulet 2005) and concentration of tourist attractions within a region (Fleischer and Tchetchik 2005), which is what Markelova *et al.* (2007) refers to as the institutional environment.



Torres and Momsen, (2004) also propose a classification of these conditions with respect to market conditions: transportation facilities, promotion of local food, farmer access and bureaucratic structures.

According to the all the aforementioned authors and their empirical studies, variables selected for research on supply chain partnership development are the following:

1. Quantity (size): kilograms of sold product (total) to suppliers in the region, as proxy of capacity of production. Quantity is mentioned repeatedly as an important variable for selection of supply chain partners. According to Hertel (2011), available technology as well as land availability determines, among other variables, production and therefore quantity can partially account for technology and land availability.
2. Price: dollars per unit of sold product. Price is often mentioned as one of the most important variables and it is also related to quantity and quality.
3. Method of transportation: although the method of transportation can be related to the quantity, quality and price of the products, it also belongs to the governance structure of the supply chain. Governance structures consider whether the method of transportation is owned by the farmer, owned by a third party or owned by the buyer (hotel and restaurant), and this can define who controls/governs the supply chain.
4. Quality: measured as the percentage of rejected product per delivery.
5. Education of decision makers: education includes formal education as well as informal education. Informal education (training courses) are especially important to quantify in the agricultural sector, in which farmers usually have rather low education levels but can gain capacities from experience or informal training courses given by leading institutions considered as stakeholders in the region.
  - Years in formal schooling
  - Number of training courses attended
6. Years in business. This indicator would be used as proxy for performance, trust and managerial skills, assuming that a farmer or a hotel/ restaurant with good managerial skills and general performance can gain trust from supply chain partners and can strengthen its market knowledge. Nonetheless, both parties will indicate how important their partners' years in business is to them.
7. Location: Farmers and hotels and restaurants can determine distance to the destination as well as price of transportation.
8. Associative culture. The indicator includes which group farmers belong to, as well as for how long they been part of the group and how helpful they think belonging to the group is. Hotels and restaurants would also be asked about their associative skills and how important they are to both groups in partnership development along the supply chain.
9. Risk: Actors make decisions in order to avoid risk, since their degrees of risk aversion may vary; farmers often are risk-averse (Debertin 2012). For this case, risk includes political stability and economic stability, which can be measured by the perception of corruption (macro level) and the agricultural work force (micro level).

10. Water and waste management. Since the approach of this study is sustainable development, actors' managerial strategies toward conservation is included, and therefore, their perception of the importance of water management one of the most important inputs in the agricultural sector (FAO 2003).
11. Access to irrigation: area equipped for irrigation as a percentage of agricultural area (FAO agri-environmental indicators) (UN 2007).
12. Organic area: the percentage of total agricultural area (FAO agri-environmental indicators) (UN 2007).

Finally, authors referring specifically to the tourism industry consider aspects from the tourist demand side—in the end, the characteristics of the tourist define what the hotels and restaurants will offer according to their wants and needs. Therefore, tourists' willingness to pay for sustainability and uniqueness of the experience (Bohdanowicz *et al.* 2001, CREST 2012, UNEP 2011), as well as the chef's preferences and his interest in sustainability (Torres and Momsen 2004), are also factors to be considered. However, these aspects would be addressed from the perspective of the decision makers, *i.e.* the hotel/restaurant managers, under the assumption that they know the market.

Restaurants and hotels were asked about their sustainability concerns and their current involvement in sustainable tourism programs, community organization and their availability to work with small and medium farmers as their main source of fresh food.

La Fortuna offers positive characteristics in terms of regional sustainable development; the proposed methods are based on characteristics and peculiarities of small and medium enterprises, qualitative perception of linkage creation from actors of the supply chain, and a systemic approach within a regional development proposal.

### 3. Assumptions

Based on the literature review and the research objectives, the following assumptions will be considered for previous analysis of results:

1. Behavior and decision making of hotels and restaurants

Hotels and restaurants behave the way they do because they know and adapt to the clients' needs. In sustainable supply chain management, according to Seuring and Müller's theoretical framework (2008), the supply chain is organized by the focal companies—in this case, hotels and restaurants. These make their decisions based on their contact with their clients, whose preferences are materialized in the supply chain by the focal company. Therefore, the study assumes consumers (tourists) and their needs are represented by the hotels and restaurants as they make their decisions according to their market knowledge.

2. Every supply chain is interdependent

Interdependence of supply chain actors is also considered a fundamental topic for improving supply chain performance since demands from tourists should be incorporated in the previous links of the supply chain until reaching farmers.

3. Transportation systems are linked to costs (transaction) and governance structures

Transportation methods are decided upon by economic possibilities and governance structures and their associated transaction costs and are not arbitrarily chosen, since it is considered one of the most important variables for analysis of supply chain management. Therefore, decisions of both sides on how to source fresh products depend on transaction costs and these shape the governance structure chosen by both parties involved in the transaction.

4. Suitability of selected variables

Variables selected for analysis are those commonly identified in previous empirical research, and although both farmers and restaurants would be interviewed based on these, an open question is left so that they can add other variable(s) that are fundamental to selection of supply chain partners.

Farmers as well as restaurant and hotel managers do not base their decision-making process on profit maximization alone but consider other social and environmental variables.

5. Lack of sustainability when regional production is not integrated into supply chain management analysis.

The supply chain of fresh products in La Fortuna is not sustainable, based on the definition of sustainable supply chain management (SSCM), which includes collaboration among stakeholders.

6. There is an optimum when selecting partners for both farmers and restaurants that can be estimated by their perception of others' characteristics and conditions.

## 4. Methods

The following section describes the location of the study as well as the proposed qualitative and quantitative methods for addressing this research.

### 4.1 Location

The research was conducted in La Fortuna, San Carlos, due to characteristics of the region that makes it appropriate for believing that linkage creation among stakeholders in the agri-food supply chain can provide win-win situation in a sustainable environment. The concept of sustainable tourism includes community involvement, social participation, local sourcing, and economic development, among other criteria. These criteria among others are addressed by Matarrita-Cascante *et al.* (2010) as community-agency triggers toward sustainable development in their study of La Fortuna. This community has had an important expansion in the tourism sector, but sustainable tourism development in this region is not homogeneous on a country level. La Fortuna's sustainable development is higher than the rest of the country a situation that corresponds to social, economic, geographic, cultural and scenic differences (Estado de la Nación 2007).

In 2013, the most economically important sectors were agriculture, tourism and trading/services in the Huetar Norte region of Costa Rica. From this agricultural production, 15 percent is transported to the rest of the country and 21 percent is targeted for the export market, in which the higher proportion corresponds to fresh agricultural products (Zevallos 2013). This data represents the importance of the agricultural sector as well as the importance of improving the local market for further economic, social and environmental development of such a touristic region.

This section describes some general characteristics of the region. The canton of San Carlos was considered as the region of analysis due to the expected inward and outward multiplying effects of creating links among agricultural and tourism agents that will scatter throughout the region as a result of the tourism attractions, located mainly in La Fortuna.

San Carlos is the largest canton in Costa Rica, with 3347,62 km<sup>2</sup> and 6.5% of the national territory. It includes the following districts: Ciudad Quesada Florencia, Buena Vista, Aguas Zarcas, Venecia, Pital Fortuna, La Tigra, Palmera, Venado Cutris, Monterry and Pocosol (Municipalidad de Carlos 2008). La Fortuna corresponds to only 6.72 percent of the territory of San Carlos, but most tourism interests focused on Arenal Volcano, Lake Arenal and natural hot springs, which are all located in La Fortuna.

Short-distance communities (less than 10 km from La Fortuna) are included in this proposal due to the agricultural potential of their sourcing hotels and restaurants located in the touristic sector. La Fortuna has well-known community-led practices, which is part of the reason why this location was chosen (Mikowski 2007). La Fortuna's economy has

increasingly shifted toward tourism in the past 30 years and it has shown rapid economic and population growth (Acuña and Ruiz 2000).

On the process of growing economic activities linked to tourism, community-oriented organization has also been part of La Fortuna's development. According to Matarrita-Cascante *et al.* (2010), community organizations for development have been part of La Fortuna's history, including ADIFORT (community Development Association), AMITOUR (Association for the Protection of the Arenal River) and ADECLA (Association for the Protection of the Quality of Water).

According to Matarrita-Cascante *et al.* (2010), La Fortuna has achieved specific sustainable practices, which are listed below:

1. Sustainable economic practices
  - Locally owned enterprises, promoting local profits
  - Diversified economy: tourism, agribusiness and agriculture
2. Sustainable social practices
  - Establishment of local social-response mechanisms
  - Creation of social responsibility and justice programs
  - Opposition to undesired gaming and sex-related activities
3. Sustainable environmental practices
  - Established organizations for natural resource conservation
  - Creation of environmental education programs in schools
  - Construction of sewage and water treatment plant for the community
  - Establishing of recycling programs in hotels
  - Establishment of zero carbon-emission goals

Nonetheless, sustainability cannot be reached until social, economic and environmental development are totally fulfilled and therefore to consider the region sustainable would be naïve until better development indexes are achieved by the host communities.

The Human Development INDEX (HDI) is only presented on a canton level: San Carlos as a whole is 34th in Costa Rica, with 0.79; on the other hand, the poverty index is 20,254, locating the region as the 54th canton in terms of poverty (UNDP/UCR 2011). Even though the canton has a good HDI, its poverty index is in the upper half of Costa Rica's poverty rates, indicating the need to boost economic opportunities to reduce poverty rates.

In terms of the Social Development Index (SDI),<sup>1</sup> district information is available and presented in Table 5 to enable full understanding of the social and economic context. All of the districts are located in a category of low or medium development.

---

<sup>1</sup> The Social Development Index includes four main pillars: education, social participation, health and economics, and it is used in politic decision making in terms of social development. For more information: <http://documentos.mideplan.go.cr/alfresco/d/d/workspace/SpacesStore/ab677d6c-fafd-4128-86df-a6aa04ab70ef/IDS%202013%20resumen.pdf>

Table 5. Social Development Index per district of San Carlos

District	SDI	Classification
Ciudad Quesada	66.6	Medium
Florencia	59.8	Medium
Buena Vista	57.3	Low
Aguas Zarcas	55.1	Low
Venecia	61.6	Medium
Pital	49.6	Low
Fortuna	56.4	Low
La Tigra	59.4	Low
Palmera	61.3	Medium
Venado	47.2	Low
Cutris	40	Very low
Monterrey	50.4	Low
Pocosol	41.5	Very low

Source: (*Municipalidad de San Carlos 2008*), (*MIDEPLAN 2013*)

For all of these, the lowest component in determining SDI was the economic component. (*Municipalidad de San Carlos 2008*). San Carlos is the canton in the northern region of Costa Rica that has the largest share of agricultural production, although 90 percent of the harvested area corresponds to production of only six traditional products (pineapple, orange, tropical tubers, heart of palm and grains) (*SEPSA-Procomer 2008*). Incentives for nontraditional production in the region have led to important exports of plantain, papaya, cacao, pepper and spicy chili. The northern region is also one of the most important sectors for cattle production in the country.

There are 557 large and 2718 small and medium (SMEs) enterprises in this region, of which 11 percent corresponds to tourism and 23 percent to the agribusiness sector (*SEPSA-Procomer 2008*). In terms of communal organizations, there are about 50 active organizations in different parts of supply chain and according to the local government, there are 104 hotels and 247 restaurants in San Carlos. (*Municipalidad de San Carlos 2013*)

Although this region shows proper social, economic and environmental conditions for creating a sustainable destination, it cannot be considered as sustainable until development and social indexes place most of the community in a better standard of living. This can be promoted by linking a large share of the poorest population to the most rapidly growing industry—tourism.

#### 4.2 Quantitative and qualitative methods

The following sections describe general approaches for both qualitative and quantitative methods that were combined to evaluate the holistic approach of a system that includes not only qualitative perspectives but also quantitative bases for decision-making processes and

policy implications for modeling sustainable destinations within the sustainable development concept.

The structure of the following sections is based on the objectives. Objectives 1 and 2 are presented in the quantitative methods and objectives 3 and 4, which are a continuum of the results of the first two objectives, are presented under quantitative methods.

### **Qualitative methods**

For methodological criteria, Zuckerman (2003) identifies what Laumann *et al.* (1983) call the nominalism and the realistic approaches to network development. In the nominalism approach, the researcher identifies a priori the relevant nodes of the network; in contrast, the realistic approach uses the network actors to identify the nodes they consider important.

Since decision-making procedures of actors along food supply chains are so complex and there are no previous studies regarding supply chain analysis in La Fortuna, the proposed methodology for the identification of important networking actors along the supply chain was guided by the supply chain principle of identifying the main input-output proposed by Gereffi *et al.* (2005). For stakeholders, the proposed methodology was the realistic approach, since there are not many previous studies that determine those important nodes of the network. Nevertheless, previous research in La Fortuna that considers stakeholders was considered for analysis.

Along with suggestions from most authors cited in the literature review in working with smallholders and the abovementioned networking strategy, it is mandatory to generate participatory methodologies since collaboration requires validation from different stakeholders. Realistic approaches are idiosyncratic of a region and tend to include only important linkages and exclude the least important ones (Zuckerman 2003). Since the approach for development in this study is regional, a realistic approach would lead to a better understanding of the region as perceived by their participants.

For a holistic approach and analysis of the structure of the supply chain, in-depth interviews were carried out with the main stakeholders of the region. These interviews provided the needed inputs for further analysis and interpretation of the quantitative results, general characteristics of the supply chain, governance structures and the interactions of actors in the food supply chain.

According to Pereira *et al.* (2013), in-depth interviews involve not only asking questions but the systematic recording and documenting of responses, coupled with intense probing for deeper meaning and understanding of the responses.

Boyce and Neale (2006) define in-depth interviewing as a qualitative research technique that involves conducting intensive individual interviews with a small number of respondents to explore their perspectives on a particular idea, program or situation. The main benefit of



conducting in-depth interviews is the collection of detailed information that would be used to understand how the system of the supply chain is constructed.

Some characteristics that differentiate in-depth interviews from other qualitative research methods are the following (Pereira *et al.* 2013):

1. Open-ended questions. Questions should be designed so that the respondent needs to elaborate on the response and not limit himself or herself to a yes or no response.
2. Semi-structured format. Although a prestructure of the interview is necessary, other questions may flow naturally from the responses given by the respondent.
3. The interviewer should seek understanding and interpretation.
4. Conversational. The main participation should be that of the respondent, while the interviewer should conduct the interview as a conversation.
5. Responses and nonverbal behavior should be recorded.
6. Record reflections. Feelings about the interview should also be recorded as soon as the interview is over.

Therefore, in-depth semi-structured interviews were conducted with the main associations, local governments, hotel and restaurant managers, agricultural producers and other important actors either mentioned in previous literature of this region or mentioned by other selected stakeholders.

This first section was used for qualitative analysis and to start developing the system underlying the fresh-food supply chain of hotels and restaurants of La Fortuna. Once the structure of the supply chain was developed, a validation process with the interviewed respondents was conducted in a workshop.

## **Quantitative Methods**

The third objective of this research focused on analyzing the most important variables considered in vendor selection of small and medium farmers from the touristic perspective as well as from the farmers' perspective. These perspectives of selection of supply chain partners are not straightforward but rather a series of ambiguous variables that correspond to vague concepts, so a fuzzy logic approach was proposed. Variables were considered ambiguous because the relative importance of each of these with respect to each other depends on usually non-measured criteria. Fuzzy logics aimed to measure this vagueness.

Decisions of actors along the supply chain are based not only on one or two criteria but on a set of criteria. Although there are several studies related to understanding the relationships among actors, these depend not only on economic aspects but also social ones, linked to traditions and to history or background of the region. For the fourth objective of this research, a model that could include these concepts was proposed. This model also includes fuzzy logic, specifically Fuzzy TOPSIS in order to model the decision-making process and the best commercialization alternatives for creation of the value chain.

Since perceptions of supply chain actors are dynamic, the approach suggested requires the perception of both farmers and hotel and restaurant managers/owners to evaluate the joint decision-making process of supply chain partnership development. Both parties were assessed from their perspective of desirable characteristics of their partners, as well as their own characteristics to perform a comparative analysis from what parties demand and what they can supply.

Although transportation is also a key criterion for supply chain analysis, instead of interviewing transporters all required information from their side was obtained by questions to their sellers (farmers) and their buyers (hotels and restaurants).

### **Sample size**

There are 104 hotels and 247 restaurants in San Carlos according to local government licenses; these represent the demand side of the population. From this list, the several hotels that did not include restaurants were not be interviewed. Also, some small restaurants and hotels were closed by the time the research was conducted; therefore, the population was reduced to 53, including hotels and restaurants.

From the supply side, SMFs from the canton of San Carlos were considered as the population. This information was only aggregated by canton, and although it was requested by district, the National Statistics and Census Institute (INEC) does not provide accurate data of farmers of selected products because of confidentiality issues. Therefore, the only available information was the number of people dedicated to the primary activities that include agriculture, farming and fishing.

To estimate the sample size, since there is no possibility of calculating the variance of the population, a standard error of 0.1 was considered for the analysis. When the population size is available, the finite population correction factor (Student Learning Center 2006) is used. This is given by equation 1:

$$n = \frac{n_o * N}{n_o(N - 1)} \quad (1)$$

Using the simple random sampling method for each stratum (stratified sampling), the following sample sizes were estimated:

1. The sample of farmers is of 100; since the number of farmers per district per product is not available, there is no correction factor and with a standard error of 0.1, the sample size is 100 farmers.

$$n_F = 100$$

2. A list of all patents in La Fortuna was obtained from the San Carlos local government; however this database was adjusted only to hotels that include restaurant or food services. All other hotels/restaurants were contacted by phone to ask them whether they were willing to collaborate. Since the beginning of the process, 10 restaurants indicated no kind of collaboration and therefore, the population size was reduced to only 53 restaurants.

$$n_{H\&R} = \frac{100 * 53}{100 + (53 - 1)} = 35$$

This sample size of 35 buyers was divided proportionally to the number of hotels and restaurants in the region.

In order to develop this research, some agricultural products were selected. The selection of these depended, however, on in-depth interviews conducted with the main agricultural-related stakeholders. Another aspect to be taken into consideration is the proportion of selected products by farmers in the region; therefore, our selection of products depended on expert criteria and a sufficient number of farmers producing the proposed products.

Although supply chains were analyzed independently, only farmers related to these products were interviewed; they were, however, asked about other products they have so that the analysis would maintain a holistic and systemic approach.

### **Fuzzy logic**

Fuzzy logics is used especially when dealing with vague concepts (Guzmán and Castaño 2006), such as with criteria for decision making that are not clear and are biased toward personal perspectives and past experiences, since fuzzy logics intends to measure perceptions.

There are several approaches to modeling sustainable supply chains (S. Seuring 2013), including life-cycle assessment (LCA) models, equilibrium models (EM), multi-criteria decision making (MCDM) and analytical hierarchy process (AHP). For this case study in which we want to identify how a buyer-seller selection of their supply chain partner is made, the AHP allows the researcher to quantify the relative importance of each variable considered for this purpose by both parties.

### **Fuzzy AHP**

The AHP, which is a multi-objective decision-making technique (Saaty 1990), considers that each decision maker creates an empirical decision by a hierarchy process. According to Seuring (2013), “The AHP allows evaluating complex decision situations, where environmental and economic goals are assessed at the same time.” This adapts to the

sustainable approach of the research since variables from economic, environmental and social aspects can be considered under the same scheme for a decision-making process.

Then again, decision makers find it more convenient to express interval judgments rather than fixed-value judgments due to the fuzzy nature of the comparison processes (Bozdağ *et al.* 2003), and therefore vague concepts can be quantified via fuzzy logic. For this research, a fuzzy AHP was carried out as a procedure to explain and optimize the mixture of factors (variables) considered for a decision-making process of partnership selection. On a second step, a Fuzzy TOPSIS was carried out to optimize the selection of partners for a better sustainable supply chain performance according to the abovementioned variables obtained from previous literature review.

SMFs, as well as hotel and restaurant managers were interviewed via verbal ranking of variables, which determine the decision-making process of choosing vendors (suppliers) and buyers. These variables derive from the previous literature review and were translated into quantitative variables to create indicators for performance and selection of the best commercialization alternatives for farmers/hotels/restaurants. However, when quantifying these variables, each of them would be understood as a triangular fuzzy number.

The fuzzy AHP aims to measure the degree of importance of dynamic variables that come into place when choosing supply chain partners. Expected results from this methodology include: 1) the identification and ranking of dynamic variables from both perspectives (sellers and buyers) and 2) the identification of the desired criteria in order to be successfully included in a supply chain.

From the fuzzy TOPSIS, the expected results are 1) the best actors from both sides from the supply chain and 2) the best option of commercialization strategy according to the optimal ideal solution.

Finally, a joint analysis of both methodologies provided the gap (distance) between farmers and hotel and restaurant managers with respect to selection of supply chain partners. The distance was estimated according to fuzzy numbers coming from farmers' perspectives that were compared to the hotel and restaurant managements' fuzzy numbers. The distance between these two was understood as a gap analysis in a fresh products value chain in the region, and this indicator was understood as willingness to keep doing business, as a proxy for trust.

Since the decision of vendor selection is influenced by different criteria, the opinion from each supplier or consumer will differ from the opinions of the others. However, global results can be obtained from the fuzzy AHP and TOPSIS. The importance of the variables in the decision-making process of vendor selection is not clear; they depend on respondent subjectivity, hence a fuzzy approach is suggested.

To understand fuzzy sets, the first step is to recognize that while a conventional set is dichotomous, a fuzzy set allows membership to a specific concept in the interval from 1 to 0, retaining the two qualitative states of full membership and full non-membership to a certain criterion. For this analysis, we consider desired characteristics (good) and undesired characteristics (bad) for each variable, categorized in a five-point Likert scale. Although this may seem a continuous variable, the main input from a fuzzy approach is more empirically grounded and more precise (Ragin 2000).

The fuzzy principle states that everything is a matter of degree. In terms of understanding fuzzy sciences, fuzzy can be interpreted as multivariance (Kosko 1993). And diversity occurs not only in configuration of set members but also to the degree to which they belong to such sets (Ragin 2000).

Fuzzy logic intends to measure the entropic nature of some decision making (Kosko 1993). It does not draw hard lines between opposites and that is why this method is ideal for subjective decisions addressed in this case. Several recent case studies use fuzzy set theory to methodically explain supplier selection (Zouggari and Benyoucef (2012), Chen, Y (2011), Zeydan *et al.* (2011) and product development (Büyüközkan and Feyzioglu 2004), as well as sustainable impact assessment (Sami *et al.* 2014) and supply chain performance (Devo-Ganga and Ribeiro-Carpinetti 2011), since these problems depend on vague concepts.

For this case study, the decision-making process considers linguistic variables that, within the fuzzy logic thinking, would be perceived as a membership function for some criteria. For social sciences, forcing a dichotomist answer is possible and usually done, but there could be information loss in doing so because no account is taken of the degree (Nguyen and Walker 2000); therefore, this approach intends to analyze, as much as possible, how supply chain actors chose their partners. A precise translation from linguistic and understandable variables in the social sciences to a strictly mathematical matrix was done in order to derive a structured and consistent decision-making process.

For this particular case of modeling sustainable supply chain decision-making processes, each previously identified variable linked to the farmers' participation in a sustainable supply chain would be introduced as linguistic concepts that farmers and hotel and restaurant owners can identify and rank according to their subjective criteria. These linguistically understood variables were later translated into fuzzy numbers that describe the membership function to the specific criteria.

An ordinary subset of A of a set U is determined by its indicator function or characteristic function  $X_A(x)$  (Shepard 2005).

$$X_A(x) = \begin{cases} 1 & \text{if } x \in A \\ 0 & \text{if } x \notin A \end{cases} \quad (2)$$

By allowing variables to be in the interval [0.1] they are in a range from these two numbers rather than restricted to the two-element set {0,1}. A fuzzy subset of a set U is a function  $U \rightarrow [0,1]$ .

Figure 5 represents the triangular membership function, which is used for the fuzzification of linguistic variables. Values are expressed qualitatively by linguistic terms and quantitatively by a membership function. Fuzzification is the process that relates numeric values of the crisp variables to linguistic ones. The figure shows how each variable is explained by three numbers (a, b, c); therefore, the fuzzy number associated to each particular variable would be given by these numbers.

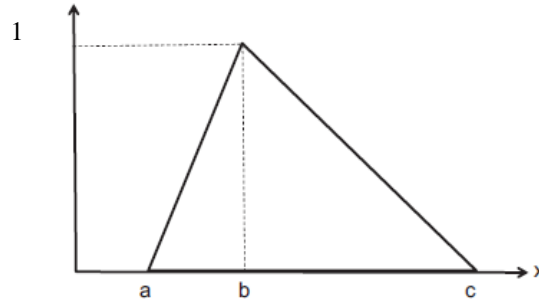

Figure 5. Membership function representation (Source. Adapted from Ganga and Carpinetti, 2011)

For a fuzzy set  $A: U \rightarrow [0,1]$  is called a membership function and the value  $A(u)$  is called degree of membership of  $u$  in the fuzzy set. Fuzzy sets analyze the varying degree to which cases belong to sets (Ragin 2000). In Figure 6, values on the x-axis range from 0 to 10 and on the y-axis from 0 to 1.

A triangular fuzzy number is obtained from each variable's membership function  $\mu_a$  and it comes from the following equations (Zadeh 1965):

$$\mu_a(x) = \begin{cases} 0, & x \leq a \\ \frac{x-a}{b-a}, & a < x \leq b \\ \frac{c-x}{c-b}, & b < x \leq c \\ 0, & x > c \end{cases} \quad (3)$$

These equations aim to measure the slopes of the triangular membership function; for this case, we would assume the same slopes for each criterion, as they are supposed to behave as a normal distribution.

The interpretation of a triangular fuzzy number is best explained by the graphical interpretation provided by Hassall (1999). The distance between the scores is represented by a linguistic attribute of ordinal importance of the variable in the decision-making process. The respondents—small and medium farmers and hotel and restaurants managers—explained variables by linguistic concepts. The quantitative distance between perceptions was then quantified by fuzzy numbers.

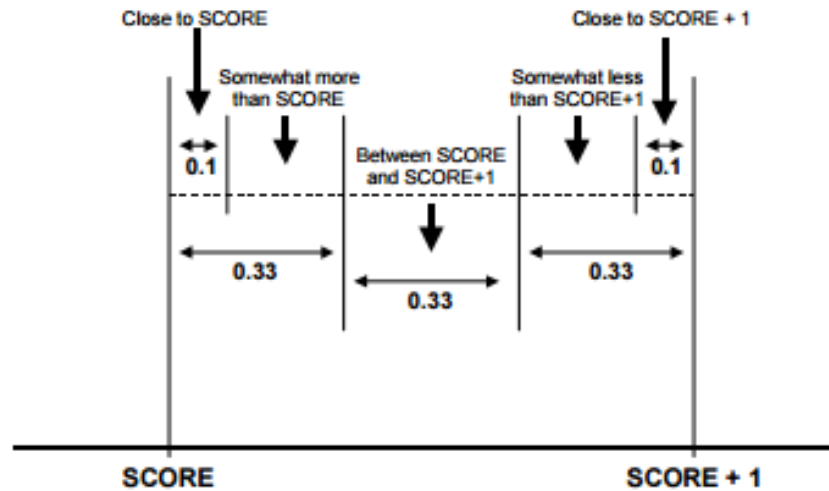

Figure 6. Fuzzy triangular number representation (Source: Hassall 1999)

The fuzziness of the representation of linguistic variables is graphed in Figure 7 for a fuzzy representation in which from each of the linguistic representation, there is common ground between adjacent concepts.

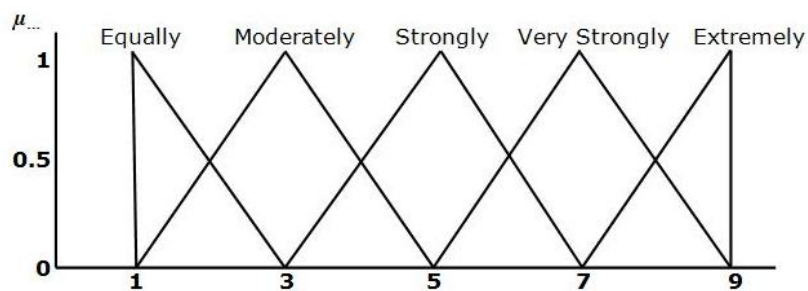

Figure 7. Linguistic variables for the importance weight of each criterion (Source: Kabir and Hasin 2011)

The distance between scores is the distance between the two triangular fuzzy numbers and it is determined by

$$d(\hat{a}_1, \hat{a}_2) = \sqrt{\frac{1}{3} [(a_1 - a_2)^2 + (b_1 - b_2)^2 + (c_1 - c_2)^2]} \quad (4)$$

General steps for addressing fuzzy membership scores, according to Ragin (2000), are the following:

1. Specify the relevant domain. It is the set of cases that have been selected for analysis and the concordance of these with theoretical bases.
2. Define the fuzzy sets that follow the concepts of guidance of the investigation (these are the sets of variables to be included in the study).
3. Determine the type of fuzzy set that is feasible for each concept. This step includes theoretical as well as empirical evidence.
4. Determine the likely range of fuzzy membership scores.
5. Identify empirical evidence that supports and is appropriate for indexing fuzzy membership scores. For this step, membership scores may be calculated by the researcher and measured for each respondent or they can be more straightforward, with respondents directly labeling each response from a scale.
6. Translation of empirical evidence into scores.

Since a selection of actors to be included in a supply chain is a multi-criteria decision-making problem, an AHP is used since it is one of the most extensively used methods, mainly because it can combine qualitative and quantitative criteria (Efendigil *et al.* 2008) (Figure 8). It was proposed by Saaty (1977, 1980) and includes:

1. Define the problem and determine the kind of knowledge the problem is looking to solve.
2. Problem decomposition: the problem is structured into criteria and sub-criteria that are considered for the decision-making process.
3. Construct a set of pairwise comparison matrices. Each criterion in an upper level is used to compare the respective sub-criteria. In this analysis, the relative importance of each element is computed measured by a pairwise comparison.
4. Synthesis of priorities: weights of each of the elements are computed by eigenvector analysis.



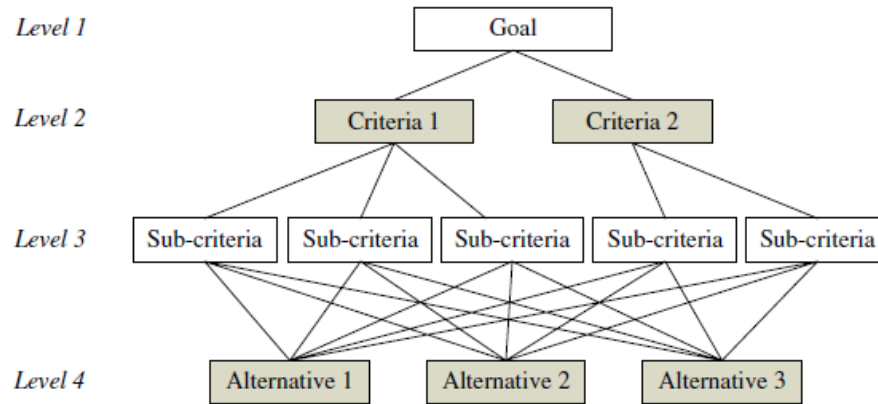

Figure 8. AHP hierarchy structure (Source: Efendigil et al. 2008)

The answers of each farmer for each variable were included in a matrix (P-Matrix), in which each column represents the producers' behavior (attitude) toward a theoretical variable. Each of these answers characterizes the respondents. In the same way, hotel and restaurant respondents have their own matrix (H&R-Matrix) in which variables are the same, but they are measured from the perspective of these actors. This procedure was done twice: once when they were asked about the sub-criteria (in order to create the  $C_i$ ) and then again when they were asked about the importance of each criterion in relation to each other.

The abovementioned matrices use the fuzzy AHP to obtain a holistic variable referred to as "Suitability for supplier selection index" that includes all the criteria suggested by previous empirical research. This variable, was evaluated from two perspectives: the farmers and the hotel and restaurant managers were compared by a gap analysis. The gap between these variables measured from two perspectives would be an indicator of supply chain performance and linkage between the agricultural sector supply and the tourism demand for food.

The sub-criteria considered for this research is a result of previous empirical research and case studies regarding small and medium farmers, the tourism sector and the decision-making process linked to supplier selection and development into a supply chain. The grouping variables (criteria) used for this analysis was based on the 5Capital tool developed by CATIE (Donovan and Stoian 2012), since it has proven to provide important insights about supply chains. However, this fuzzy AHP approach provides a wider understanding and analysis of how sub-criteria are interlinked in the decision-making process of the supply chain (Figure 9).

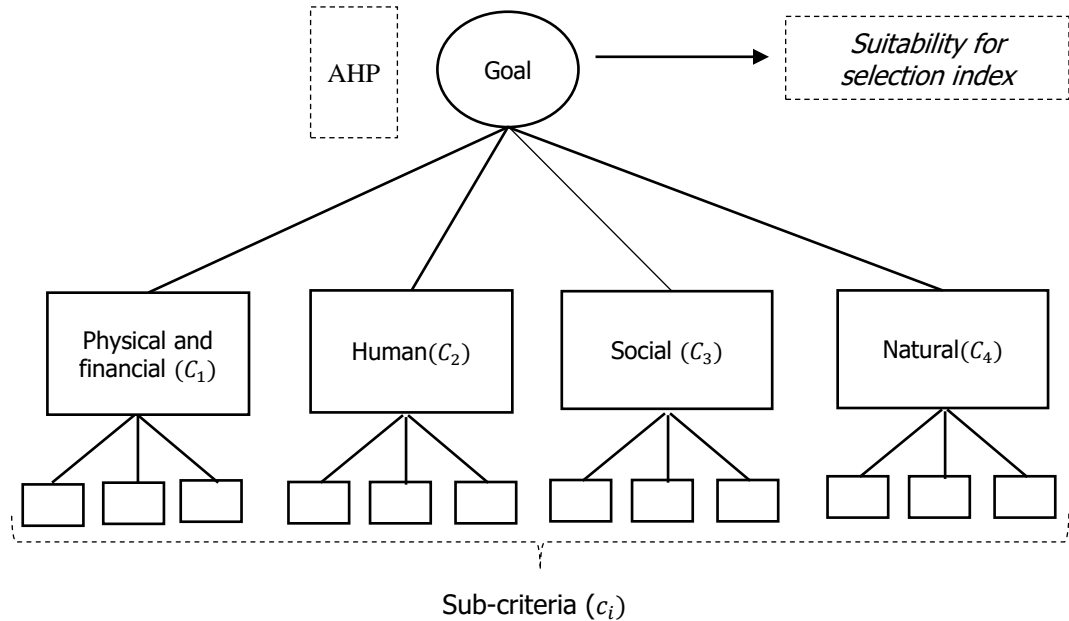

Figure 9. Proposed Hierarchical Method for variable ranking and identification

Donovan and Stoian 5 Capitals make reference to the following criteria, including their classification and variables for analysis:

1. Physical and financial capital: these two were included as one variable since they are very-much related to production capacity
  - Quantity (size): kilograms of product sold (total) to suppliers in the region, as proxy of capacity of production: (technology, land)
  - Price: dollars per unit of sold product
  - Quality: measured as the percentage of rejected product per delivery
2. Human capital, as a proxy for product characteristics
  - Method of transportation (own-sublease-sold)
  - Location of farmers and hotels and restaurants
  - Education:
    - i. Years of formal schooling
    - ii. Number of training courses attended
3. Social capital (including political)
  - Years in business (as proxy for performance, trust and managerial skills)
  - Associative culture (groups belong to, length of affiliation with each group and how helpful it is)
  - Risk: as political stability and economic stability; perception of corruption and of agricultural workforce.
4. Natural capital

- Water and waste management: likelihood of farmers to develop water management strategies
- Access to irrigation: area equipped for irrigation as a percentage of agricultural area
- Organic area as a percentage of agricultural area

These variables were classified according to the key household and business assets for value chain development (Donovan and Stoian 2012). A similar grouping approach is also suggested by Springer, *et al.* (2015). These four criteria (dimensions): physical and financial capital, human capital, social capital and natural capital, are understood as  $C_i$ .

The fuzzy AHP needs a subjective evaluation of the importance of each variable relative to the others in the decision-making process of belonging to a value chain. This procedure is carried out by asking respondents the relative importance of each sub-criterion with respect to each other. The proposed method is a two-stage fuzzy AHP; therefore, the same subjective evaluation would also be carried out for the criteria ( $C_i$ )—each criterion compared to each other.

For each respondent, a pairwise comparison matrix was created by transforming each linguistic variable to a numerical relative ranking and membership function to a concept (Table 6). From all of these individual matrices, a general pairwise comparison matrix was created that evaluates the overall vague answers by fuzzy numbers. Saaty (1990) states: “The most effective way to concentrate judgement is to take a pair of elements and compare them on a single property, without concern for other properties on other elements.”

Table 6. Example for linguistic variables and fuzzy values

Likert-scale linguistic variable	$a_i$	$b_i$	$c_i$
Very Important	8	9	10
Important	6	7	8
Somewhat important	4	5	6
Somewhat unimportant	2	3	4
Very unimportant	0	1	2

The fuzzy numbers would be used in this five-ranking scale; the following numbers were used (since working with a 10-point scale is recommended) (Table 7).

Table 7. Transformation of linguistic variables into fuzzy numbers

Likert-scale linguistic variable	Fuzzy number
Very important	(8,9,10)
Important	(6,7,8)
Somewhat important	(4,5,6)
Somewhat unimportant	(2,3,4)
Very unimportant	(0,1,2)

Each farmer and each hotel and restaurant owner/manager were asked to rank all variables in linguistic terms to each other in order to compute Table 8. To construct this table, respondents compare each variable to all other variables. This procedure was conducted to identify the importance of the sub-criteria ( $c_i$ ) within a dimension and for criteria ( $C_i$ ). For each of these, farmers and hotel/restaurant respondents were asked to indicate by linguistic variables how important each one was with respect to all of the other variables. Table 8 is just an example of ranking of criteria for either the group of farmers or the group of hotel and restaurant/hotel managers.

Table 8. Individual fuzzy comparison matrix example

	$c_1$	$c_2$	$c_3$
$c_1$	1	VI	I
$c_2$	1/VI	1	VI
$c_3$	1/I	1/VI	1

This linguistic table was translated into fuzzy numbers (Table 9); therefore instead of understanding linguistic variables as such, for each ranking we get a fuzzy number.

Table 9. Transformation of linguistic variables to fuzzy numbers

	$c_1$	$c_2$	$c_3$
$c_1$	(1,1,1)	(8,9,10)	(6,7,8)
$c_2$	(1,1,1)/(8,9,10)	(1,1,1)	(8,9,10)
$c_3$	(1,1,1)/(6,7,8)	(1,1,1)/(8,9,10)	(1,1,1)

Saaty's original classification of linguistic variables was performed on a nine-point scale and has been adapted to fuzzy numbers by several authors, including Kabir and Hasin (2011) (see Table 10).

Table 10. AHP fuzzy values and their interpretation

Linguistic scale	Value	Fuzzy Value	Interpretation
Equal variable		(1,1,1)	Same variable compared to itself
Equal importance	1	(1,1,3)	Requirements <i>i</i> and <i>j</i> are of equal importance: two alternatives contribute equally to the objective
Moderate importance of one over another	3	(1,3,5)	Moderate importance: experience and judgement slightly favor one activity ( <i>i</i> ) over the other ( <i>j</i> )
Essential or strong importance	5	(3,5,7)	Strong importance: experience and judgement strongly favor one activity ( <i>i</i> ) over the other ( <i>j</i> )
Demonstrated importance	7	(5,7,9)	Very strong importance: experience and judgement very strongly favor one activity ( <i>i</i> ) over the other ( <i>j</i> ). (Demonstrated dominance in practice)
Extremely preferred	9	(7,9,9)	Extreme importance: the evidence supporting one activity over the other is of the highest possible order of affirmation
	Reciprocals		If requirement <i>i</i> has a lower value than <i>j</i>

Source. Adapted from Saaty (1980) and Kabir and Hasin (2011)

This same procedure was carried out for each respondent for each dimension (criteria) in order to obtain five pairwise comparison matrices: one per each criteria (four) and one to calculate the relative importance of the criteria to specify the suitability for the supplier selection index.

To obtain the triangular fuzzy numbers, the operation is as follows:

$$\frac{\hat{a}_1}{\hat{a}_2} = \left( \frac{a_1}{c_2}, \frac{b_1}{b_2}, \frac{c_1}{a_2} \right) \quad (5)$$

These matrices describe how both groups analyze the relationship between variables and is a proxy of how the decision-making process was carried out for selecting supply chain partners.

To obtain this aggregate comparison matrix, the following equations proposed by Büyüközkan and Feyzioglu (2004) can be used:

$$a_{ij} = \min (a_{ijk})$$

$$b_{ijk} = \left( \prod_{k=1}^K b_{ijk} \right)^{1/k} = (b_{ij1} * b_{ij2} * \dots * b_{ijk})^{1/k} \quad (6)$$

$$c_{ij} = \max (c_{ijk}).$$

Once the matrices are obtained for each sub-criteria and criteria, the fuzzy AHP follows these steps:

1. Sum of each row of the triangular fuzzy comparison matrix

$$S_i = \sum \hat{a}_{ij} = \left( \sum_{j=1}^m a_{ij}, \sum_{j=1}^m b_{ij}, \sum_{j=1}^n c_{ij} \right), i = 1, 2, \dots, n \quad (7)$$

2. Normalization of the sums of rows

$$\hat{S} = \sum_{j=1}^m \hat{a}_{ij} * \left[ \sum_{i=1}^n \sum_{j=1}^m \hat{a}_{ij} \right]^{-1} \quad (8)$$

3. Compute the degree of possibility of  $\hat{S}_i \geq \hat{S}_j$ , according to

$$P(\hat{S}_i \geq \hat{S}_j) = \begin{cases} 1 & \text{if } b_i \geq b_j \\ 0 & \text{if } a_j \geq c_i \\ \frac{c_i - a_j}{(c_i - b_i) + (b_j - a_j)} & \text{otherwise,} \end{cases} \quad (9)$$

4. Calculate the degree of possibility of  $\hat{S}_i$  over all other fuzzy numbers, according to

$$(\hat{S}_i \geq \hat{S}_j) | j = 1, \dots, n; j \neq i = \min_{j \in (1, \dots, n), j \neq i} P(\hat{S}_i \geq \hat{S}_j) \quad (10)$$

5. Define the priority vector of the fuzzy comparison matrix:

$$w_i = \frac{P(\hat{S}_i \geq \hat{S}_j) | j = 1, \dots, n; j \neq i)}{\sum_{k=1}^n P(\hat{S}_k \geq \hat{S}_j) | j = 1, \dots, n; j \neq k)}, \text{ where } w_i \text{ is a non - fuzzy number} \quad (11)$$

With all of these matrices, it is possible to compute one that explains the global selection of all possible suppliers. This procedure would estimate the hierarchical importance of the selected variables. These are the relative importance of the sub-criteria and the relative importance of each of the criteria (four) in order to understand how a decision-making process is made.

### **Fuzzy TOPSIS**

In the attempt to measure closeness to the optimal solution, a technique for supplier selection using fuzzy logic, fuzzy TOPSIS was first developed by Hwang and Yoon (1981) to find the best option from all the feasible alternatives in multi-criteria decision-making processes. This method indicated that the best alternatives should have the farthest distance from the negative ideal solution and the shortest to the positive ideal solution (Chen, C 2000). The positive ideal solution is the maximization of the preferred characteristics and the minimization of those that are not.

Based on theoretical research for identifying factors of success, criteria for selection are threefold since variables were categorized into three main criteria: social, economic and environmental; however, all of the actors included in the sample were asked individually about these variables. The main objective with this method was to identify the best option for commercialization from the farmers' point of view and from the restaurant managers' point of view.

Smallholders do not determine criteria for partner selection solely on individual interactions between farmers and buyers; they also consider interaction among each other, in their social context and with their other partners along the supply chain, *for example* their farther linkages. Based on Granovetter's (2005) strength of weak ties, data from linkages nearest to the customer can provide information to better identify those aspects crucial to appropriate selection of smallholders. In this case customers, mainly tourists, are those who interact directly with local restaurants, and their willingness to collaborate with sustainable tourism options were also be analyzed.

Fuzzy TOPSIS has been used widely for vendor selection (Zare *et al.* 2015, Patil and Kant 2014, Prakash and Barua 2015, Adil Baykasoğlu 2015, Kusumawardani and Agintiara 2015, Tyagi *et al.* 2014) and recent research addresses sustainability issues (Kusi-Sarpong *et al.* 2015, Kannan *et al.* 2014), therefore basing the decision-making process for partner selection on more than economic factors. Social conditions and environmental awareness affect all parts of society and the managerial decision-making processes (Hart and Dowell 2011).

The literature review regarding vendor selection and fuzzy logic is analyzed in the following sections. Vendor selection processes have also been analyzed via fuzzy logic. Vendor selection has been a widely discussed topic in supply chain management because the selection of suitable suppliers can decrease purchasing costs and increase organization ability—selecting the best supplier is regarded as a strategic factor (Roshandel *et al.* 2013). Efendigil *et al.* (2008) analyze an environmental holistic approach in vagueness situations through fuzzy set theory. They mention that it can be applied to an AHP in determining relationships in order to obtain a more robust and more quantitatively oriented AHP process.

Kannan *et al.* (2009) proposed fuzzy TOPSIS for the vendor selection process and interpretive structural modeling to analyze the interactions among criteria; interpretive structural modeling is a computer system that may be used to break up a problem into a set of sub-problems.

Ganga and Carpinetti (2011) also proposed a fuzzified methodology for supply chain performance. The analysis included SCOR (supply chain operations reference model) performance measurements and a hierarchical approach in which the main performance attributes were reliability, flexibility, responsiveness, costs and assets.

The proposed methods regarding fuzzy TOPSIS come from the need to propose the best type of organization for the supply chain, calculated according to the perceptions of both farmers and hotel and restaurant owners and/or managers. Sodhi and Prabhakar (2012) state, “Fuzzy TOPSIS can be used to evaluate multiple alternatives against the selected criteria. In the TOPSIS approach an alternative that is nearest to the Fuzzy Positive Ideal Solution (FPIS) and farthest from the Fuzzy Negative Ideal Solution (FNIS) is chosen as optimal.”

Usually, the technique is used for evaluating and ranking different suppliers or buyers; however, in this case, instead of analyzing specific hotels, restaurants or farmers, the goal is to analyze the best distribution channels from both perspectives. In terms of supply chain management and governance structures, these distribution channels would be classified as hybrid, market and hierarchical structures—hybrid mechanisms are understood as any other selling strategy that is neither direct nor hierarchical. Therefore, the alternatives in this case would be types of structures rather than supply chain actors. For each of these structures, actors need to mention how important each of the variables is when considering and analyzing a supply chain partnership.

The analysis was carried out separately, from the farmers’ perspective and from the restaurant manager’s perspective; both groups had decision makers, which were the ones interviewed. Decision makers (DM) can buy or sell their products in the following ways:

1. Farmers: directly to consumers (farmers market), supermarkets, restaurants (almost directly to consumer), packing company/factory or intermediary



2. Restaurants: directly from farmers, through a wholesaler or by a hierarchical mechanism (managed by the restaurant's administration)

These supply chain alternatives would be noted as  $A_i$ .

The first step is to obtain the relative importance of each criterion for decision makers when they choose a supply chain partner. This matrix (Table 11) shows the relative importance of each criterion, according to the weights given by decision makers (similar results can also be obtained from fuzzy AHP).

Table 11. Criteria weighed by decision makers

	$C_1$	$C_2$	...	$C_j$
$DM_1$				
$DM_2$				
$\vdots$				
$DM_k$				

On a second step, we obtain a different matrix in which decision makers characterize each alternative according to the same criteria. This matrix is presented in Table 12:

Table 12. Alternative rating by decision makers

	$A_1$			$A_2$			$A_i$		
	$DM_1$	...	$DM_k$	$DM_1$	...	$DM_k$	$DM_1$	...	$DM_k$
$C_1$									
$C_2$									
$\vdots$									
$C_j$									

The entries of the alternative rating by decision-makers' matrix are  $x_{ij}^k$ , where  $k$  is the number of respondents,  $i$  is the number of alternatives and  $j$  is the number of criteria.

With the abovementioned matrix, a fuzzy aggregated matrix that groups the information in one group decision-making matrix, using these formulas:

$$\begin{aligned}
a_{ij} &= \min^k \{a_{ij}^k\} \\
b_{ij} &= \frac{1}{k} \sum_1^k b_{ij}^k \\
c_{ij} &= \max^k \{c_{ij}^k\}
\end{aligned} \tag{12}$$

The same procedure can be done using the simple mean of each of the entries of each fuzzy number. The aggregate fuzzy decision-making matrix is the transpose of the previously mentioned matrix:

$$\begin{array}{rcccccc}
& & C_1 & C_2 & C_3 & \dots & C_n \\
A_1 & \tilde{a}_{11} & \tilde{a}_{12} & \tilde{a}_{13} & \dots & \tilde{a}_{1n} \\
A_2 & \tilde{a}_{21} & \tilde{a}_{22} & \tilde{a}_{23} & \dots & \tilde{a}_{2n} \\
D_{m \times n} = & A_3 & \tilde{a}_{31} & \tilde{a}_{32} & \tilde{a}_{33} & \dots & \tilde{a}_{3n} \\
& & & & & \dots & \\
& & & & & & \\
A_m & \tilde{a}_{m1} & \tilde{a}_{m2} & \tilde{a}_{m3} & \dots & \tilde{a}_{mn}
\end{array}$$

Once this matrix is obtained, we normalized it, creating an R matrix.  $R = (r_{ij})$ . Its entries were obtained by using the following equation. They need to be calculated for each criterion and for each alternative.

$$r_{ij} = \left( \frac{a_{ij}}{c_j^*}, \frac{b_{ij}}{c_j^*}, \frac{c_{ij}}{c_j^*} \right), j \in B \tag{13}$$

$$r_{ij} = \left( \frac{a_j^-}{c_{ij}^*}, \frac{a_j^-}{b_{ij}^*}, \frac{a_j^-}{a_{ij}^*} \right), j \in C \tag{14}$$

$$c_j^* = \max_i c_{ij} \text{ if } j \in B \quad (15)$$

$$a_j^- = \min_i a_{ij} \text{ if } j \in C \quad (16)$$

These entries provided the normalized aggregated fuzzy decision matrix that had the same format as the aggregate fuzzy decision making matrix. Each of these entries was part of the normalized fuzzy decision-making matrix.

In a second step of fuzzy TOPSIS, we also needed to transform responses of weight into an aggregated weights matrix in the following way:

$$\begin{array}{ccccccccccc} (w_{11}^1, & w_{12}^1, & w_{13}^1), & (w_{21}^1, & w_{22}^1, & w_{23}^1), & (w_{31}^1, & w_{32}^1, & w_{33}^1), & \dots, & (w_{j1}^1, & w_{j2}^1, & w_{j3}^1) \\ (w_{11}^3, & w_{12}^3, & w_{13}^3), & (w_{21}^3, & w_{22}^3, & w_{23}^3), & (w_{31}^3, & w_{32}^3, & w_{33}^3), & \dots, & (w_{j1}^3, & w_{j2}^3, & w_{j3}^3) \\ \vdots & & & & & & \ddots & & & & & & \vdots \\ (w_{11}^k, & w_{12}^k, & w_{13}^k), & (w_{21}^k, & w_{22}^k, & w_{23}^k), & (w_{31}^k, & w_{32}^k, & w_{33}^k), & \dots, & (w_{j1}^k, & w_{j2}^k, & w_{j3}^k) \end{array}$$

Then, for each criterion, we obtained an aggregated weight per criterion:

$$w_{j1} = \min^k \{w_{1jk}\}, \quad w_{j2} = \frac{1}{k} \sum_{k=1}^k w_{2jk}, \quad w_{j3} = \max^k \{w_{3jk}\}, \quad (17)$$

which is  $\hat{w}_{ij} = \min(w_{i1}^1, w_{i1}^2, w_{i1}^3); \frac{1}{k}(w_{i2}^1, w_{i2}^2, w_{i2}^3); \max(w_{i3}^1, w_{i3}^2, w_{i3}^3)$ .

The weighted normalized fuzzy decision matrix (Table 13) was created by multiplying the normalized aggregate fuzzy decision matrix by the previously calculated weight per criterion.

Table 13. Weighted normalized fuzzy decision matrix

Criteria	$A_1$	$A_2$	$A_3$
$C_1$	$\tilde{a}_{11} * \hat{w}_{11}$	$\tilde{a}_{21} * \hat{w}_{21}$	$\tilde{a}_{31} * \hat{w}_{31}$
$C_2$	$\tilde{a}_{12} * \hat{w}_{12}$	$\tilde{a}_{22} * \hat{w}_{22}$	$\tilde{a}_{32} * \hat{w}_{32}$
$\vdots$		$\ddots$	$\vdots$
$C_j$	$\tilde{a}_{1j} * \hat{w}_{1j}$		$\tilde{a}_{3j} * \hat{w}_{3j}$

\* Both  $\tilde{x}_{ij}$  and  $\hat{w}_{ij}$  are fuzzy numbers.

Finally, we calculated the FPIS ( $A^+$ ) and FNIS ( $A^-$ ).  $A^+$  is dependent on  $k$  fuzzy variables taking the maximum value by row of the  $c_{ij}$ . To obtain the  $A^-$ , we took the minimum value by row of the  $a_{ij}$

$$A^+ = \tilde{a}^* = \{(\max c_{1j}), (\max c_{2j}), \dots, (\max c_{ij})\} \quad (18)$$

$$A^- = \tilde{a}^- = \{(\min a_{1j}), (\min a_{2j}), \dots, (\min a_{ij})\} \quad (19)$$

We then estimated the distance between  $A^+$  and each of the alternatives and of  $A^-$  and each of the alternatives according to:

$$d(\tilde{a}_{ij}, \tilde{a}^*) = \sqrt{\frac{1}{3} [(a_1 - a^*)^2 + (b_1 - b^*)^2 + (c_1 - c^*)^2]} \quad (20)$$

$$d(\tilde{a}_{ij}, \tilde{a}^-) = \sqrt{\frac{1}{3} [(a_1 - a^-)^2 + (b_1 - b^-)^2 + (c_1 - c^-)^2]}. \quad (21)$$

Therefore, we get six distances—from each alternative to the FPIS and from each alternative to the FNIS.

Table 14. Example of distances from FPIS and FNIS for alternatives

Crit eria	FPI	FPI	FPI	FNI	FNI	FNI
	S (A <sub>1</sub> )	S (A <sub>2</sub> )	S (A <sub>3</sub> )	S (A <sub>1</sub> )	S (A <sub>2</sub> )	S (A <sub>3</sub> )
C <sub>1</sub>						
C <sub>2</sub>						
⋮						
C <sub>j</sub>						

The distance ( $d_i^*$  and  $d_i^-$ ) of each weighted alternative from the FPIS and the FNIS was computed by these equations:

$$d_i^* = \sum_{j=1}^k d(\tilde{a}_{ij}, \tilde{a}^*) \quad (22)$$

$$d_i^- = \sum_{j=1}^k d(\tilde{a}_{ij}, \tilde{a}^-) \quad (23)$$

Finally, this procedure aimed to estimate the alternative with the highest closeness coefficient:

$$CC_i = \frac{d_i^-}{d_i^- + d_i^*} \quad (24)$$

From Table 14 we could obtain the data to estimate the CC and be able to say which is the best alternative for sustainable supply chain management. We obtained this CC from two perspectives (from farmers and from hotel and restaurant managers) because the study was conducted from both perspectives.

## 5. Fresh supply chains for sustainable destinations: case study in La Fortuna

### 5.1 Introduction

Sustainable supply chain management in agriculture is particularly important since sustainable agricultural products mean better standards of living for rural communities (United Nations 2015) and healthier products for an increasingly conscious tourism population (European Commission 2013, Giovannucci et al. 2012).

Agri-food supply chains are complex and further research can improve competitiveness of host regions, especially when these can be sustainable destinations. Sustainability can also be encouraged by a tourist-driven perspective. In this regard, the Global Sustainable Tourism Council (GSTC) in 2013 introduced a new certification especially designed for sustainable destinations (GSTC 2014) since there is growing consumer demand for sustainable tourism.

Matarrita-Cascante *et al.* (2010) addressed sustainability in La Fortuna and suggested several criteria by which this tourist region may be considered sustainable. Local sourcing and local prosperity are fundamental aspects for sustainable tourism. However, Canedo-Rivas (2012) analyzed how agricultural farmers are not included in the local supply chain and local restaurants do not source from local farmers.

Regional competitiveness is a key aspect of competitive supply chains especially if the agri-food supply chain can provide wider benefits to producers and consumers at the same time. Since sustainability in supply chains is improved by enhanced relationships among partners (Seuring and Müller 2008), this research focused on the characterization of the food supply chain in this region and the analysis of governance mechanisms toward the creation of a sustainable destination in La Fortuna.

Integration of supply chains, as well as the adoption of sustainable practices, has proven to increase performance goals in the manufacturing industry (Zhu and Sarkis 2004) and in the food industry (Vasileiou and Morris 2006 Schiefer 2002, Berno 2006). Nonetheless, management faces problems when integrating the first links of the chain (Stoian and Gotret 2011) in an upstream flow, which in this case are agricultural ones.

According to Seuring and Müller's theoretical framework (2008), the supply chain is organized by the focal company and supply chain decisions are based on governance structures. This research addressed these aspects in a descriptive study of selected products grown in the region by small and medium farmers. The main goal of this research was to gain in-depth understanding of agricultural supply chains and their dynamics within a potentially sustainable destination.

Costa Rica has emphasized its tourism attractions in terms of natural amenities, including La Fortuna, whose economy has increasingly shifted towards tourism in the past 30 years and whose economy and population have shown rapid growth (Acuña and Ruiz 2000). La Fortuna’s most important sectors in terms of economic shares are agriculture, tourism and trading/services. As for agricultural production in the Huetar Norte region of Costa Rica; 15% is transported to the rest of the country and 21% is targeted for the export market—with the highest proportion corresponding to fresh agricultural products (Zevallos 2013).

La Fortuna is located in the region of San Carlos (Figure 10), which is the largest canton in Costa Rica with 3347,62 km<sup>2</sup> and 6.5% of the national territory. San Carlos includes these districts: Ciudad Quesada Florencia, Buena Vista, Aguas Zarcas, Venecia, Pital, Fortuna, La Tigra, Palmera, Venado Cutris, Monterry and Pocosol (Local Government of San Carlos 2016). La Fortuna is the only one of these districts considered to be a tourist destination—all other are more agriculture-centered.

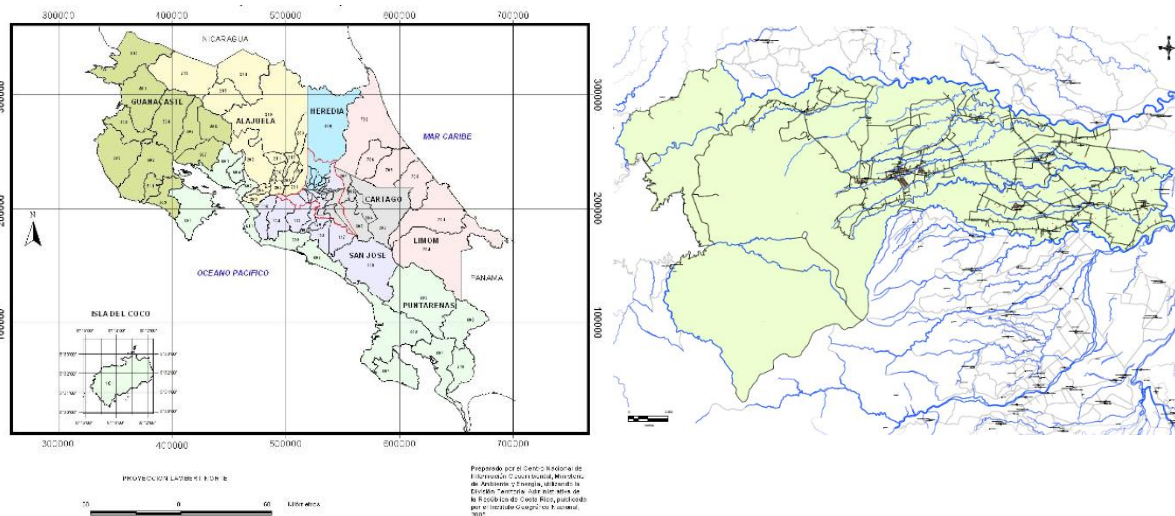

Figure 10. Map of Costa Rica and La Fortuna\* (Source: Universidad Nacional (2005) and INEC (2005); available at Mapoteca Universidad Nacional de Costa Rica

[http://www.mapoteca. geo.una.ac.cr/index.php/remository.html?func=startdown&id=50](http://www.mapoteca.geo.una.ac.cr/index.php/remository.html?func=startdown&id=50)

\*San Carlos is identified as 210 in the provincial map; La Fortuna is located in the southern part of San Carlos and is zoomed in the right map.

## 5.2 Literature Review

### Supply Chain Management

Stoian and Gotret (2011) have characterized the differences between a poor performance in a supply chain and what is considered determinant for high performance. These are usually called value chains or sustainable supply chains. These differences are presented in Table 16.

Table 15. Characterization of poor and high performance of a supply chain

<b>Criteria</b>	<b>Poor performance/supply chains</b>	<b>High performance/sustainable supply chains, value chains</b>
Purpose	Competitiveness of actors	System competitiveness and long-term vision
Orientation	Guided by the supply	Guided by the demand
Objective	Maximize earnings and minimize costs without considering aspects other than the economic ones	Add value through productivity, quality, traceability and differentiation
Vision	Commercial relationships and supply of products in short or medium term	Commercial relationships and supply of products in medium or long term, with win-win strategies
Organizational structure	Independent actors	Interdependent actors
Type of relationships	Low level of cooperation and trust among actors	Medium to high level of cooperation and trust; clear and transparent definition of norms
Information flows	Low and limited to commercial transactions	Relevant and timely for effective development of actor relationships

*Source: Bourgeois and Herrera (1999), Stoian and Gotret (2011)*

According to Pagell and Wu (2009), a sustainable supply chain has good standards on traditional measures as well as in the other dimensions included in the definition of sustainable development: social and environmental aspects. Seuring and Müller (2008) define sustainable supply chain management as the material, information and capital flows as well as cooperation among companies while achieving goals in the economic, social and environmental dimensions of sustainable development, considering that these come from client and stakeholder requirements.

From these definitions, two predominant issues can be highlighted. The term *sustainability* includes managerial decisions on economic, environmental and social criteria and sustainable supply chains demand collaboration among actors of the supply chain.

### **Supply chains and governance mechanisms**

Traditionally, smallholders are recognized as having partial integration in the market as well as limitations for operating under market principles (Friedmann 1980). The new form of agri-food governance is buyer-driven and has developed sophisticated participation rules (Vorley 2001); therefore, the implications for smallholder agriculture in the new forms of agri-food governance can be a challenge.

Peculiarities of smallholders sustain that no single model for strengthening their supply chains can apply universally (IFC 2013). The characteristics of actors, products and



governance mechanisms (Gereffi *et al.* 2005) partially define the dynamics, possibilities and strategies for successfully coordinating with actors along the supply chain.

Alternative coordination mechanisms need to be created so that small farmers are included; however, these always creates costs—transaction costs. Therefore, the objective of new institutional economics, founded by Coase (1937) and followed by Williamson (1985), is to study conditions under which firms (or supply chains) are more transaction-cost efficient than markets.

Supply chain partner selection is based on transaction costs between both parties (Hitt 2012). The process of getting to an agreement among actors generates frictions and higher transaction costs that are the result of asymmetries in access to information, bounded rationality and opportunistic behavior among actors (Williamson 1979). Transaction costs define the relationships created among supply chains.

Gereffi *et al.* (2005) suggest a governance typology in global value chains, bounded to the structural transaction-costs theory proposed by Williamson (1991), which divides supply chains into

1. Market structures: This is the lowest level of cooperation between actors in which the buying-selling rules are clear and of common understanding. Transactions are simple and there is no need for a structure to make any kind of transfer: the transactions are made in markets. There are low transaction costs so actors do not tend to deal with any kind of institutional arrangements.
2. Hierarchy: Product and transaction requirements are very specific and because of that, enterprises and supply chains tend to integrate vertically. Generally, there are larger controls over production and commercialization due to asset specificity.
3. Hybrid structures: These are structures that are not located in any of the extremes presented above. Due to differences in asset specificity, products characteristics and transaction complexity, these structures are defined as hybrid (Williamson 1991).

Gereffi *et al.* (2005) then also classified hybrid structures as follows:

1. Modular value chains: The ability of codifying product specification is less complex than the products themselves. Product specifications are codified through a common understanding between buyers and suppliers, so that they only have to work through codified products instead of analyzing the product each time the transaction occurs, reducing transaction costs.
2. Relational value chains: These take place when specifications of a product cannot be codified, transactions are complicated and the capacities of suppliers are high. In these cases, information flows and constant communication among partners is needed and therefore, changes in partners can create high costs.
3. Captive value chains. These occur when the ability to codify and product complexity specifications are high but the capacities from suppliers are low. These face changing

prices and the buyer, rather than the seller, is the most significant actor in the decision-making process.

### 5.3 Methods

In-depth interviews were carried out with important institutions in the region, including La Fortuna's Development Association (ADIFORT), the regional Ministry of Agriculture (MAG), the National Bank of Costa Rica, the Costa Rican National Chamber for Ecotourism and Sustainable Tourism (CANAECO) and the Costa Rican Chamber of Restaurants (CACORE). These interviews were intended to address the region's plan for development as well as sustainability's triple bottom line and development perspectives.

#### Methods for data collection: farmers

The district of La Fortuna was established as the site for analysis because of its sustainable destination framework. Although the borders of the wider supply chain spread to the international market, the focus for analysis and the farmers' sample was estimated according to the geographic limits of the district, since one of the objectives of sustainability is to source locally and the goal of the research is to address this specific topic.

In 2014, INEC conducted the agricultural census, but there is no accurate information about this study's population target since farmers dedicated to agricultural products were not identified on a regional scale (district) but on a wider canton scale. Information about the exact number of farmers dedicated to the selected products was not available.

Meetings with La Fortuna regional MAG were the basis for product selection. Products suggested by the regional director were papaya (*Carica papaya*), yuca/cassava (*Manihot esculenta*) and plantain (*Musa balbisiana*, *Musa acuminata* or a mix of these) (Hernández 2015). However, pineapple (*Ananas comosus*) and taro (*Colocasia esculenta*) production were also included in the questionnaire. Pineapple was included because it can be produced in this region; in fact, 47 percent of Costa Rica's pineapple production is located in the northern region of the country (CANAPEP 2015) and because it is widely consumed on a national scale. Taro was also included in the analysis because it is produced in La Fortuna and it represents an opportunity for promoting local food in restaurants targeted to tourists. This is one of the objectives of the National Plan for Healthy and Sustainable Food promoted by the Costa Rican Chamber of Restaurants (CACORE 2015).

To get an approximate number of farmers in the region, geographical information on people dedicated to agriculture was obtained from INEC, as well as desegregated demographic, social and economic data. All other information was obtained from field research.

In an exploratory phase, pilot interviews were carried out in training sessions organized by MAG-La Fortuna. Three visits were planned in order to identify the main regions and to

validate the information provided by INEC and the selected products before interviewing farmers and restaurants.

A stratified sample was estimated according to the proportion of people dedicated to the agricultural sector of the economy in the district. Six communities within La Fortuna were considered for the sample selection: Agua Azul, Sonafluca, Tres esquinas, La Perla, Los Ángeles, El Tanque and San Jorge. Sample size for farmers was estimated on a 90 percent confidence interval and 108 farmers were interviewed in these communities.

Direct questionnaires were applied from September to December 2015 in several visits to the region. All routes were designed according to INEC's map, previous visits and information about important farmers in the region and others farmers had previously mentioned. All houses in the selected regions were visited, and those identified as small and medium farmers were interviewed.

Methods for data collection: hotels and restaurants

For selection of the hotels and restaurants, a list of hotel and restaurant licenses was requested from the San Carlos local government. From this list, a total of 325 licenses were active; however, several belonged to the same management. For example, if a hotel had three restaurants, there would be four different licenses, one for the hotel and three for the restaurants although procurement and managerial decisions were taken by the same person. There were several hotels on the list that did not include restaurants and therefore these were not interviewed. In addition, some small restaurants and hotels had closed by the time the research was conducted; therefore, the population was reduced to 53.

All restaurants were contacted; however, the response rate was 50 percent of the population. Interviews were carried out from September 2015 to January 2016 in previously requested meetings with the procurement managers; 30 complete questionnaires were filled out by restaurants in La Fortuna.

## **5.4 Results**

### **Supply chain analysis**

This section characterizes the main actors of the fresh produce supply chain and addresses their dynamics and governance structures.

#### **Input sources**

There are two main agricultural input suppliers in La Fortuna: El Colono and Almacén Agroveterinario Dos Pinos, which are private institutions. Farmers often get their inputs from these as well as either from governmental institutions (especially papaya seeds) or from their buyers, who often provide some inputs if their sellers are committed to a longer-term agreement.

Institutions such as MAG are often committed to supporting farmers to getting their inputs at lower prices; however, 10 farmers mentioned how input prices are high and they believed the government should support them in lowering at least the main agrochemical inputs. There were no farmer organizations in this region to strive for policy reforms that could eventually lead to structural policy changes that could lead to lowering input prices.

## Farmers

The population in La Fortuna is 73% rural and 27% urban (INEC 2015) and most farmers live in rural regions, close to their farms. Socioeconomic development (SD) is divided into the five categories,<sup>2</sup> shown in Table 15.

Table 16. Socioeconomic levels of La Fortuna’s population, 2015

Socioeconomic level	Frequency	Percentage (%)	Cumulative percentage (%)
Low	9	5.9	5.9
Medium-low	12	7.9	13.8
Medium	104	68.4	82.2
Medium-high	26	17.1	99.3
High	1	.7	100.0
Total	152	100.0	

*Source. INEC, 2015*

N = 152 (GMU: geographical minimum units: INEC’s measurement of minimum geographic measurements for analysis)

Most of the population (82%) has a low, medium-low or medium SD; however, the largest percentage (68.4%) is considered as medium while only 1 GMU is considered as high and 9 as low. In farmers’ households, there were an average of 3.91 people per household (SD = 1.60), the mean, median and mode were all rounded to four people per household, following a normal distribution. The national average of persons per household for 2014 was 3.30. National averages per quintile go from 3.57 members (fifth) to 3.10 members (first). In La Fortuna, 35.6% of households had more than four members, which is slightly higher than the fifth quintile in national terms.

The number of household members was usually negatively correlated with per capita income. Therefore, lower national per capita incomes can be expected in La Fortuna; however, income and agricultural incomes are not the main focus of this research.

Farmers have a mean of 25.26 years of experience working in the agricultural sector, with a minimum of two years and a maximum of 62, therefore there is high variation (SD = 13.943). While some have worked as farmers their entire lives, some others changed recently shifted to agriculture, since the construction sector deteriorated in the region a few years ago.

<sup>2</sup> Methods for the selection of each person’s socioeconomic level include a series of variables according to the “Encuesta de Hogares de Costa Rica” available at <http://www.inec.go.cr/enaho/result/resultados.aspx>.

Both, agriculture and construction jobs are considered non-skilled labor and workers can switch easily from one activity to the other. Some farmers (eight) that have recently moved to agriculture, mentioned how they were forced to shift from other tourism-infrastructure related jobs to agriculture as a consequence of the recent economic crisis of 2008–2009.

In terms of agricultural dependency for economic performance, 63% of farmer households depend only on agricultural production, while 37% do not. As for their proportional income distribution, 73% mentioned all of their income comes from agriculture and farming.

Table 17. Income from agriculture and education level of farmers, La Fortuna, 2015

Education level	Income from agriculture					Total
	100%	75%	50%	25%	NA	
Less than 6 years	17	1	3	2	1	24
	70.8%	4.2%	12.5%	8.3%	4.2%	100.0%
6 years	45	4	4	5	0	58
	77.6%	6.9%	6.9%	8.6%	0.0%	100.0%
Less than 11 years	12	0	1	0	0	13
	92.3%	0.0%	7.7%	0.0%	0.0%	100.0%
11 years	4	4	1	1	0	10
	40.0%	40.0%	10.0%	10.0%	0.0%	100.0%
Higher education	2	1	0	0	0	3
	66.7%	33.3%	0.0%	0.0%	0.0%	100.0%
Total	80	10	9	8	1	108
	74.1%	9.3%	8.3%	7.4%	0.9%	100.0%

Most farmers received almost all of their income from agriculture-related activities whether these were solely crop production or farming; some farmers also combined it with other jobs such as drivers, agriculture machinery rentals, apartment rentals or security guards. These were the jobs mentioned most and their working relatives work mostly in beauty salons or as elementary schoolteachers.

Most of the jobs farmers mentioned are non-skilled labor or low-skilled labor. This situation corresponds with farmers' low academic profile; since 75.9% only have elementary school education, including 22.2%, which who did not complete it. Only three people from the sample (2.8%) had achieved some kind of higher education. However, even when education increased, farmers still received most of their income from agriculture ( $\chi^2 = 1.29$ ).

Around half of farmers in this region usually grew more than just one product (44.4%), while 55.6% stuck to one product. Most popular crops were cassava (55%), papaya (38%), plantain (35%) and plantain (30%). Farmers do not rely only on one product—they mentioned prices fluctuate significantly during the year and having more than one product allowed them

to increase their financial stability. Some farmers grew a mixture of these products or mixed them with less popular products such as ginger and sweet potato (Figure 11).

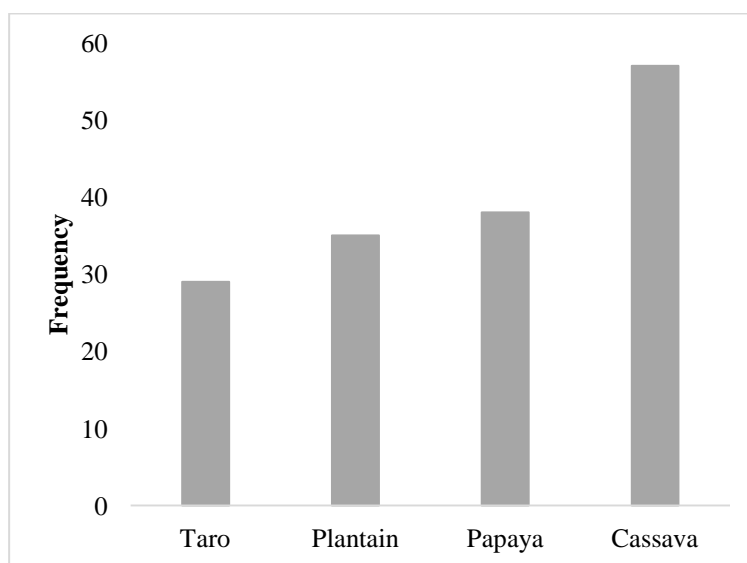

Figure 11. Frequency distribution of selected products for La Fortuna, 2015

Although there is much research on the importance of written contracts to enable farmers to increase their development goals, especially for economic stability, in La Fortuna, most farmers worked with their supply chain partners without a contract (69.4%), while 23.1% used a verbal contract and only 7.4% had a written one. According to their responses, this situation occurs because they preferred to choose from the market if there were any buyers who would pay a higher price than the last person/company that bought their product.

Creating trust among supply chain partners is fundamental to sustainable supply chain performance; however, there were no risk-sharing mechanisms for farmers to rely on their buyers, and therefore they were constantly searching for better options; which farmers understand as buyers who offer better prices.

In terms of association and organizational skills, only 39 farmers (36%) mentioned they belong to some type of farmers' organization; however, these are no local cooperatives or farmers' associations but rather larger countrywide associations.

Most farmers sold their produce to intermediaries and packing companies (Table 18), although they often mentioned they were uncomfortable when asked about why they chose to work with them; however, these actors were the only ones who would buy their entire production and collect it at the farm gate. Restaurants bought mostly from intermediaries

(Table 19), reasons being they already know their suppliers or because of ease of the transaction.

Table 18. Frequency of supply chain partner selection for farmers, La Fortuna, 2015

Type of buyer	Frequency	Percentage (%)
Intermediary	53	49
Factory	39	36
Farmers' market	10	9
Supermarket	5	5
Restaurant	1	1
<b>n =</b>	<b>108</b>	<b>100</b>

Table 19. Frequency of supply chain partner selection for restaurants, La Fortuna. 2015

Type of seller	Frequency	Percentage (%)
Intermediary	19	63
Both	7	23
Farmers	4	13
<b>n =</b>	<b>30</b>	<b>100</b>

### Local buyers

Restaurant decision makers had a mean of 9.84 years of experience, with some mentioning less than a year of experience and the maximum respondent mentioned 30 years of experience (SD = 7.761).

Educational level of restaurant managers or procurement managers was higher than farmers, which was expected; 43.33% of them had gone on to higher education (college) and 46.66% had between six and 11 years of high school education. These are significantly higher than the educational level of farmers, although farmers have more experience. Also, 60% had received training courses while working in the tourism or sourcing sectors.

Farmers' lack of organization replicated in the restaurant sector: 73.3% did not belong to any type of organization either in the tourist sector or in the sourcing sector. Tourism organization is a common topic in the country, especially when dealing with sustainability issues. CANAECO, the Costa Rican National Chamber for Ecotourism and Sustainable Tourism, supports business linkages, for example as well as sustainable initiatives and training courses; however, there are only five hotels affiliated with this institution in La Fortuna (Carballo 2015).

In spite of sustainability promotion and the national certification for hotels, restaurants and tour operators, only seven restaurants claimed they are part of the Costa Rican Sustainable

Tourism Certification (CST), three other respondents claimed they have strived for it in the past but did not continue to pursue it since it has very high standards and they were not sure if it is worth it.

In terms of contract mechanism, 50% worked with their fresh produce suppliers without a contract, 40% with a verbal contract and 10% with a written contract. This situation had a similar pattern in the previous stage of the supply chain since most farmers did not work with a written contract; however, most restaurants worked directly with intermediaries rather than farmers.

### **Exports and the Costa Rican market**

In farmers' interviews, seven mentioned they own their means of transportation and therefore they sold directly to the local farmers' market, in street sales and in three cases they transported directly to the National Center for Food Supply and Distribution (CENADA), located 125 km away. In cases in which farmers sold to intermediaries, once these products left their farms, most farmers did not know where or to whom products were sold; only five farmers who sold to intermediaries knew where their products were finally consumed.

Production from farmers who sold directly to factories was turned into either frozen products or chips (especially in the case of plantain and cassava). Papaya was also exported either fresh or frozen. There are four factories in La Fortuna, which can absorb the local supply and usually buy all of the farmers' harvest, which is a valuable asset from the farmer's perspective; two of these factories sold their produce exclusively to foreign markets and the other two sold mainly to the local market, at least as first tiers.

According to FAOSTAT (2015), Costa Rica exports fresh plantains to North America and the European Union (EU); however, exports significantly reduced from 2006 to 2009 and have remained low since then. Dry plantains were first exported in 2006 and exports have increased significantly, especially from 2010 on. Fresh papaya is mainly exported to Canada, since papaya from Costa Rican is banned from entering the United States. Taro is exported to North America and to the EU in small quantities however, exports began in 2012, and so this is a new market. From these selected products, cassava is the most important product in the foreign market. The main market for cassava is the United States since it has been about 70% of total exports for the past 10-year span.

### **Supporting actors**

The University of Costa Rica (UCR), Costa Rica's Technical Institute (TEC) and CATIE (Tropical Agricultural Research and Higher Education Center) are universities that farmers recognize because they have received previous support from them in the form of research and improving their production capacity. The National Institute of Learning (INA) is a teaching center widely recognized by small and medium farmers and hotels and restaurants because



they have received training courses from this institution, such as. Food-handling courses and agricultural technical courses.

ADIFORT, La Fortuna's development association has a major influence on a local scale because of its economic capacity and good organizations skills; it works from two main pillars—social projects and economic projects (Román 2015). ADIFORT is involved in the organized farmers' market, which is held every Friday.

The main source of income and social mobility for families in La Fortuna is tourism or tourism-related activities; but the second most important sector is agriculture (Román 2015, Hernández 2015). As for financing, most loans were related to tourism; however, in recent years, these have decreased and people in the region have searched for financing for other types of businesses, including agriculture and farming projects (Rodriguez 2015).

From the perspectives of tourism and restaurants, the Costa Rica Tourism Institute (ICT) plays an important role in promoting the country as a sustainable, green and authentic destination; however, restaurants and hotels in the region are more acquainted with ICT because of the CST certification program, which is the national certification for sustainable tourism.

CATUZON is the Northern Region Tourism Chamber, which is a community organization that promotes tourism, especially linked to the northern part of the country; 43 businesses are affiliated with this chamber (ICT 2016), including hotels, restaurants, tour operators and transportation agencies. In terms of tourism promotion and support, only five institutions are currently affiliated with CANAECO, the main advocate of sustainability and tourism (Carballo 2015). There is not enough information to ascertain why hotels and restaurants do not participate as members of these institutions; however, there are low organization skills and a lack of willingness to associate among both sectors in the region.

Procomer, which is the national institution in charge of promoting exportation of goods and services, assesses all companies interested in exporting; including those who export agricultural goods. It provides guidance to new exporters and those who already export; Procomer also provides international market information; however, this institution works on a national scale.

The graphic representation of the supply chain can be observed in figure 12, where supporting actors are located outside the supply chain structure.

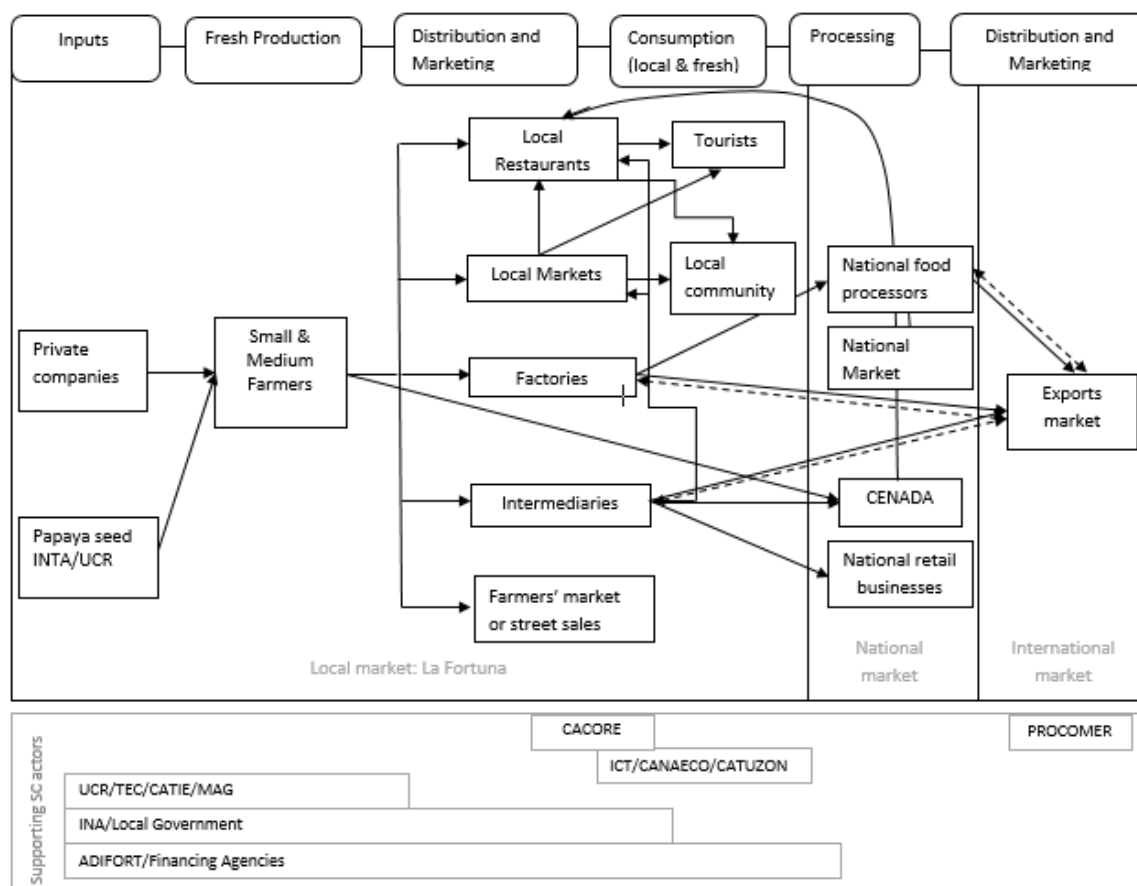

Figure 12. Supply chain of selected fresh agricultural produce, La Fortuna, 2015

## Price analysis

Farmers sell their produce to different types of consumers, classified in five different types of buyers, and the mean price paid per buyer is shown in Table 20. Price ranges according to type of buyer are significantly different for papaya and cassava, but not for plantain or taro.

Table 20. Prices received by farmers per type of buyer of fresh products, La Fortuna, 2015\*

Products	Type of buyer					Sig (0.95%)
	Restaurant	Small markets	Factory	Intermediary	Farmers' market /street sales	
Papaya		143	155	155	325	0.009
Cassava		161	156	160	304	0.000
Plantain	120	108	121	123	118	0.923
Taro	217	282.61	262.56	229.97	543.47	0.564

\*Prices in Costa Rican colons (price equivalent 544 colons = \$USD 1, 30 May 2016).

Papaya, cassava and taro: prices per kg; plantain price per unit.

Restaurants were also asked about the mean price of these products, results are shown in Table 21. There are no significant differences in this case; means prices are the same, regardless of the supplier.

Table 21. Prices paid by restaurants per type of seller of fresh produce, La Fortuna, 2015\*

Products	Type of seller			Sig (0.95%)
	SM farmer	Intermediary	Both	
Papaya	613.75	671.25	650.83	0.982
Cassava	445	449.58	427.78	0.959
Plantain	165.25	173.73	144.29	0.426

\*Prices in Costa Rican colons (price equivalent 544 colons = USD 1, 30 May 2016).

Papaya, cassava and taro: prices per kg; plantain price per unit.

Price sold by farmers to intermediaries and price at which restaurants buy from intermediaries were as follows: papaya 333.065%, cassava 180.988% and plantain 41.243%. Taro was not considered for this analysis since the proportion of restaurants who regularly bought taro was too small.

## 5.5 Discussion

Gereffi (1994) defines governance as “authority and power relationships that determine how financial, material and human resources are allocated and flow within a chain.” Governance is based on the complexity of the information between actors in the chain, how the information for production can be codified and the level of supplier competence (Gereffi *et al.* 2005).

According to Gereffi’s hybrid structure classification, the fresh agri-food supply chain of La Fortuna classifies as a captive governance structure since suppliers (farmers) depend on a small numbers of buyers who “wield a great deal of power” (G. Gereffi 1994), while small- and medium-scale farmers (SMFs) are dependent on the conditions established by their buyers.

SMFs do not have any type of farmers’ organization; all of them negotiate sale of their produce on their own. This system limits their bargaining power since they are SMFs and cannot exert any type of market power through price and volume control. All farmers have a positive perception of a potential SMF organization; however, no one has launched any initiative yet, perhaps because of lack of organization skills.

Most farmers sold their produce either to intermediaries or to factories, which determined prices. Usually, quality of agricultural products is encoded, but quality standards for agricultural products in this region are not stable; according to interviewed farmers, price and quality are relative terms. When agricultural supply is high, quality standards are very strict; however, when supply is low, buyers do not take into account their quality standards, often buying produce they would not normally buy. Nonetheless, farmers are price takers.

There is a lack of backward information along this supply chain. When farmers were asked if they knew where their produce was sold, most did not. In only five cases farmers knew exactly where their produce was consumed. Bullwhip effects would certainly affect negatively on farmers' incomes since there is no market-risk information. This is a problem in the sense that farmers would not adapt to changing trends fast enough because of their lack of awareness of market trends.

According to Seuring and Muller (2008), first tiers of the upstream sustainable supply chains would adapt to changing consumer demands either through certification systems or by focal companies. In this case, focal companies are the only source of market information for most farmers and therefore would base their farming decisions on these. Certification systems, however, are not popular in the region; none of those interviewed had enrolled in any type of certification system.

Those who make sourcing decisions in restaurants are aware of the importance of sustainability and local sourcing—they often explained their good relationships with SMFs. They know their target market and are informed of changing trends in clients' needs. Since tourism is gravitating toward sustainability and corporate social responsibility, hotels and restaurants expressed willingness to follow these patterns.

On the other side of the supply chain, farmers were willing to sell their produce to buyers other than intermediaries and factories because most of them felt prices paid for their products were not fair. However, the first problem in linking these two is quantity: if all restaurants in La Fortuna bought all of their products locally, they would purchase only 14.2% of plantains, 0.4% of cassava and 2.5% of papaya grown by SMFs.

Finally, restaurants need at least a weekly supply of fresh produce, while farmers harvest in a six-month period for cassava and taro and do not stagger their harvest in order to offer their produce consistently to local restaurants. Prior coordination is necessary so farmers plan their harvest according to their potential buyers' needs.

## **5.6 Conclusion and recommendations**

The fresh product supply chain is very complex and since there is no farmers' organization, their decision-making process in selecting partners is scattered among different buyers. In some cases, farmers even sell to intermediaries who transport products all the way to the country's urban area. On the other hand farmers buy from intermediaries who travel from this urban area to La Fortuna.

Since restaurant owners and managers are aware of the importance of buying locally, especially in the agriculture sector, there is a possibility for these to collaborate. Also, farmers would find prices paid by restaurants significantly higher than those they currently receive from their buyers, therefore there is an incentive for both sides. Nonetheless, this potential

trading mechanism would only include a small proportion relative to the number of fresh products harvested in the region.

The education level and socioeconomic conditions of farmers are still a challenge in this region; investment in these aspects could exponentially increase their possibilities for engaging in high-value global chains—to engage in value-added products or promote innovation in business models of these supply chains.

Although it is a popular characteristic in agricultural supply chains for farmers to depend on buyers, this is still a challenge, since SMFs would sell their produce whatever the price, having no control over any decision-making procedures aside from their harvest; there are no bargaining mechanisms, and conditions are set only by buyers.

Collaboration among SMFs and local restaurants would help the tourism sector not only to comply with sustainable certification standards but also to provide an enhanced experience for tourists by offering local food, which has proven to increase tourist satisfaction in other locations (R. Sims 2009). Governance mechanisms from the tourism sector that push this type of initiative are essential since the agricultural sector of the supply chain lacks organization skills. CACORE's national plan for local food is a possibility for supply chain enhancement; however, incentives for restaurants to participate should be promoted in order to obtain higher policy implications and better standards of living for the rural areas.

Promotion of this type of initiative can promote development in rural areas, creating opportunities for people to prosper and reducing socioeconomic problems that occur with rural to urban migration. Generating possibilities for development in rural areas is key to sustainable development in a region in which most of the population is located in rural areas, often with lower standards of living.

This research provides a characterization of the fresh product supply chain and emphasizes the main issues of farmers' lack of bargaining power and market knowledge. The asymmetry of information among these two groups of actors was expected because of other empirical results; however, this research provides a full characterization of the supply chain and of its governance mechanism. Further research on how to improve bargaining power of SMFs with low individual quantities as well as improvement in association and organization skills are needed to extend benefits from supply chains and promote rural and local development.

# 6. Are prices fair in agriculture? A bottom-up smallholder perspective: Case study in La Fortuna, Costa Rica

## 6.1 Introduction

Seventy-five percent of the world's poor live in rural areas (World Bank 2008) and most of them are dependent on agriculture, which can be an especially effective arena for efforts to reduce poverty, especially in early stages of development (Kaya *et al.* 2013). A more dynamic and inclusive agricultural sector could reduce rural poverty and improve standards of living in rural areas, populated mostly by small- and medium-scale farmers (SMFs).

Pro-rural policy is vital to improve the positive effects of agriculture in these areas, such as access to assets, improved productivity, financial and risk management for small farmers and better access to markets (OECD 2009). Access to profitable markets is often a struggle for small and medium farmers since they cannot benefit from economies of scale unless they coordinate through networking or clustering (Kirsten and Satorius 2002), also a challenge.

Since agriculture is a driving force for development and SMFs often face difficulties in improving their standards of living and local development, several initiatives of voluntary certification systems have been promoted in rural areas, including certification systems such as Fairtrade.

The analysis of voluntary certification systems is a common topic for research, and it has proven to increase SMFs' benefits in some cases (Bacon 2005), though it has also had contradictory results in market access and commercialization (Francesconi and Ruben 2014). Dammert and Mohan state that "the question of how Fairtrade affects small-scale rural farmers is a contentious one" (2014) and since the perception of fair is subjective, the purpose of this research is to address what SMFs consider fair in prices and market access.

To analyze how farmers perceive fairness of prices and commercialization mechanisms, 108 small and medium farmers located in La Fortuna (northern Costa Rica) were interviewed. Farmers were asked about their perceptions on fairness of agricultural prices, their perceptions on farming compared to other economic sectors and their overall standards of living compared to other sectors.

This research was conducted in a highly touristic region promoted as a sustainable destination since most of the region's characteristics are aligned with sustainable development. However, first tiers of the supply chain, the farmers, have weak linkages and sourcing for agricultural products is fragile; in spite of the local SMFs in the region.

Although none of the interviewed farmers were currently Fairtrade certified, they were interviewed about their perception of fairness of distribution of benefits along the supply chain. The main goal of this research was to assess and analyze the perception of fairness from farmers instead of analyzing fairness from a top-down perspective. Since fresh production is highly dependent on effective supply chains, analysis also targeted whether farmers changed their perception of fairness depending on the buyer of their product.

Sustainability includes a series of three-fold objectives that are difficult to achieve, especially in developing countries. The agriculture and the food industry have become a more complex system in recent years because of high transaction costs, specialization of stakeholders and the emergence of massive corporations dedicated to the production and commercialization of agricultural food products (used as the first inputs of food supply chains).

The food industry has faced many structural changes. Food safety and quality standards have taken on a prominent role in global agricultural and food markets (Henson and Reardon 2005). Although international standards of certification bodies function as a regulatory system, these have also become central to meeting demands of consumers because they address quality and safety concerns, as well as needs of niche markets.

There is growing dominance of private standards and certifications in food supply chains. Governance structures led by supermarkets have increased their bargaining power not only in developed countries but also in developing countries (Henson and Reardon 2005). Supermarket share of food retail participation has increased rapidly in Latin America (Reardon and Berdegú 2002) as well as in other regions, converging in a worldwide trend.

There are arguments about why standards are used as barriers to trade. First, they are misused as “protection in disguise” (Maertens and Swinnen 2015), since trade liberalization measures have been enforced. Second, costs for certifications are high. Costs arise not only because of the certification per se but from investments farmers need so that they comply with the certification standards (Maertens and Swinnen 2015). World Trade Organization rules have reduced possibilities of small-scale producers to benefit from public regulation in international trade (Gibbon 2003).

Nonetheless, certification standards could also reduce information asymmetries and boost trade (Maertens and Swinnen 2015). The rationale behind standards and certification systems is that they provide reliable information to consumers. Information could be related to quality, safety, environmental concerns or social issues, such as to improving standards of living of the farmers who grew their food.

Fair trade is a popular research topic and the central characteristic of it is that the minimum price paid to farmers meets the living wage in the sector and this covers the costs of sustainable production (Dragunasu *et al.* 2013). Living wages are understood as the minimum

income for workers to meet their basic needs. Therefore, prices paid to farmers should be enough for the farmers and their families to live under decent standards of living

Fairtrade International (Fairtrade 2015) has identified three long-term goals:

1. Make trade fair: meaning resilient businesses for small farmers. Workers should receive a decent living wage and they should be able to exercise their rights and freedoms. Informed consumers demand fair trading practices while the public and private sector enable and support sustainable development practices. Nonetheless, decent living wages are defined by minimum wages of each target country.
2. Empower small producers and workers: in order to help them build organizations, improve their negotiation with buyers and employers and achieve economic stability, so that they can improve their collective influence.
3. Foster sustainable livelihoods: organize small producers and workers so that they can improve their incomes and achieve decent working conditions within sustainable ecosystems.

Fairtrade, as with other certification systems, assumes that consumers are aware, interested and willing to pay a higher price so that standards are met. Dragunasu *et al* (2013) state that “a number of studies have formally modeled the logic of Fair Trade, showing theoretically that if consumers value the nature of the production process, then voluntary certifications unambiguously improve aggregate welfare.” Although this research does not address Fairtrade certified farmers or the norms of Fairtrade, it analyzes the farmers’ perceptions of fair prices.

## **6.2 Methods**

The most common agricultural products in the region are papaya, cassava, taro and plantain, according to the regional offices of the Costa Rica Ministry of Agriculture. Selection of SMFs was done relative to these products. Sample size was estimated proportionally to the geographic distribution of farmers in the district of La Fortuna.

The sample size of 108 farmers was selected without a population estimate since no accurate information about the number of independent SMFs in this region was available. The geographic distribution of farmers was obtained from the INEC.

There was no previous information on whether these SMFs grew products themselves or were working as agricultural labor for larger farmers. Farmers who only receive a daily payment for their labor in agriculture were not considered. After initial visits, only active farmers who also make managerial decisions were considered. The interviews were conducted in the following regions: Agua Azul/La Fortuna (13%), Sonafluca (38.9%), Tres Esquinas (16.7%), La Perla (13.9%), Los Ángeles (3.7%), El Tanque (2.8%) and San Jorge (11.1%).



A standardized questionnaire was developed that included descriptive characteristics of farmers, such as their education, location, type of contract or trading mechanism and type of buyer. Fair-trade related questions were answered in five-point Likert scales (0= I fully disagree, 3 = partly, 5= fully agree).

Descriptive statistics regarding Likert-scale questions of fairness in price, market access and farmers' opportunities were carried out to analyze the degrees of agreement or disagreement of the interviewees (farmers) with the following statements:

1. Price paid to farmers is fair (S1).
2. Payments farmers receive are enough to provide their families with good opportunities (S2).
3. There are many obstacles for farmers to sell their products at a good price (S3).
4. People who engage in other economic activities provide better opportunities than agriculture (S4).

Question 1 is a direct question about price perception, questions 2 and 4 intend to provide a deeper look at fair prices because farmers can compare their living standards with others, according to the Fairtrade organization, including decent standards of living for farmers and their families.

Kruskal-Wallis tests were conducted on education, type of contract and type of buyer variables to identify whether farmers' perceptions of fairness changed according to their education, type of contract or negotiation type and type of buyer. These variables are expected to affect farmers' perceptions to some degree. To provide deeper analysis, in-depth interviews were carried out with selected farmers. The selection process for these farmers was based on recommendations of all interviewed farmers; each farmer was asked to name a representative farmer and the five most-named farmers were selected for an in depth-interview regarding fair prices, market access and farmers' opportunities.

On the other side of the supply chain, would local consumers be willing to pay more for local and sustainable food? In this region, tourism is the most important economic activity and local restaurants are targeted to tourism rather than local consumers. Therefore, 80 tourists were interviewed to provide insight on how consumers perceive collaborating with local development through tourism and their willingness to pay more for sustainable food within sustainable destinations. These results, however, are not representative of all tourist arrivals in the region; results are only used as a reference on how tourists perceive prices, local food and sustainability.

### **6.3 Results and discussion**

Results show how fairness of prices is often a conflicting topic; negative overall perceptions can be observed in figures that follow. Farmers considered prices unfair mainly because they are too low and therefore they did not surpass their average production costs, not

that farmers have these estimates. Countrywide, farmers lack the ability to estimate production costs and this situation could be more of a tradition rather than capability. Therefore, when farmers mentioned that costs were higher than prices, this assertion is often not done through an accurate estimation of costs, but rather by farmers' perceptions.

Farmers considered prices unfair because they knew prices at which consumers buy the produce, since they are also buyers of agricultural products in most cases. Farmers knew retail prices at supermarkets and knew the price gap between the prices they received for their product and the retail price.

Most farmers who sold to intermediaries or factories mentioned how their buyer did not fix prices in advance; therefore, they did not know exactly how much they were going to receive for their products. However, there were three medium farmers that have developed strategic alliances with buyers and have developed win-win situations; however, this requires larger volumes, and not all small farmers are able or willing to increase their production.

As for farmers' opportunities, they are aware of the opportunities buyers have and this is their benchmark, since they also know family members of the buyers since they often live nearby. Another point of comparison for farmers are other family members who work in other sectors, such as tourism or services in this region—the first and third most important economic activities in La Fortuna (INEC 2011).

What components should be considered to define what is fair from the farmers' perspective? From their perspectives, for prices to be fair, they must be higher than costs, so that they have a profit margin. From their perspectives, a proposal for fair estimation of prices should include:

1. Reference of regional cost estimates per product, per hectare: national information should be the base for estimating production costs. There are several available estimates that can be provided by MAG. These costs structures should be the base for the following estimations.
2. Estimation of the capital cost, as the opportunity cost of investing in agriculture. Estimations can be done according to the following equation and Table 22.
- 3.

$$\text{Capital Cost } (K_e) = R_f + B(R_m - R_f) + R_p$$

Table 22. Example of variable detail for capital cost estimation

Variables	Variable Detail	Sources
$R_f$	30-year long-term Costa Rican Euro bonus average yield	7.16%
$R_m$	Agriculture average yield	Law no. 8634: estimated by TBP*+4.5%; Farmers need 3.5% over this rate. TBP is average for 2015
$R_p$	Country risk	3%
$B$	Costa Rican annual product price volatility	According to official national markets (PIMA-CENADA)

\*TBP = tasa basica pasiva which is the Costa Rican base rate

4. For prices to be fair, the following inequality should hold:  $costs + \alpha \geq K_e$ , where  $\alpha = profits$

Another aspect to be considered in this fair price estimation is to use national-scale average yields so farmers can have both, average costs and average expected yields. Under this scenario, we could consider agricultural prices to be fair compared to other industries and indexed to national average risk.

One of the farmers said, “Tourism and general infrastructure development has decreased in the past few years and people who used to work in construction have shifted to agriculture, looking for better opportunities,” However, negative perceptions of farmers’ opportunities are predominant—it was often mentioned that buyers have better living conditions than farmers. Answers from all of the fair-price statements can be observed in Figures 13, 14, 15 and 16.

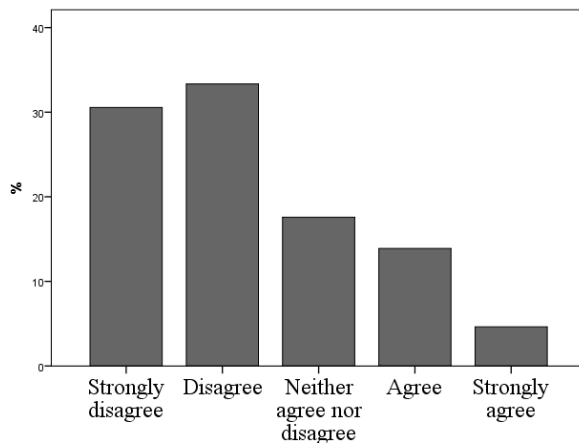

Figure 14. Price of agricultural products is fair

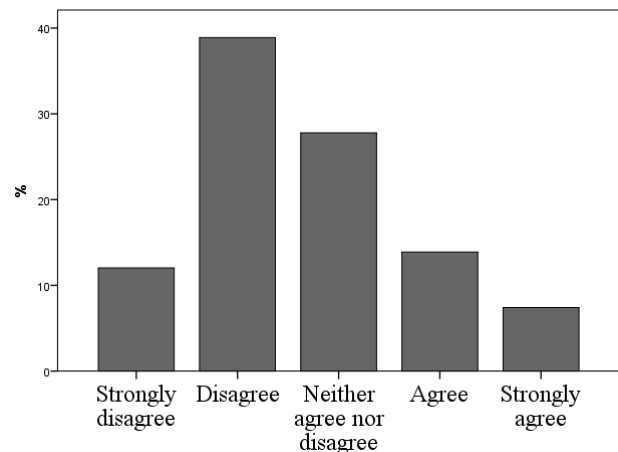

Figure 13. Payments farmers receive are enough to provide their families with good opportunities

Farmers also have mentioned the importance of market access and their lack of capacities in this regard; they would sell “to whoever would buy their product,” because “they do not have other buyers to choose from.” There are governmental information systems for agricultural markets provided to farmers about market knowledge; however, when asked about

these, they mentioned that they do not know how to take advantage of them or “do not believe in those mechanisms” because “local markets are different.”

Market access is a main problem for farmers: they grow their products without previously agreeing with any type of buyer and since most farmers do not know buyers’ requirements beforehand, these stipulations may be impossible to meet once production is harvested.

A recurrent topic related to farmers’ market access was organization of smallholders, although there was no initiative by farmers to create any type of institutional arrangement to improve these issues. Several research programs have focused on the analysis and creation of smallholder organizations as well as how determinant it could be in achieving development goals, especially in rural/agricultural areas.

There is strong evidence of a good associative culture in the region in other areas, such as La Fortuna’s Development Association and the local chamber of tourism linked especially to tourism and local development (Matarrita-Cascante *et al.* 2010): however, agriculture has been left out of synergies derived from community organization. Market opportunities could also improve for SMFs if they collaborated and gained bargaining power by providing the larger volumes needed to enter higher value markets.

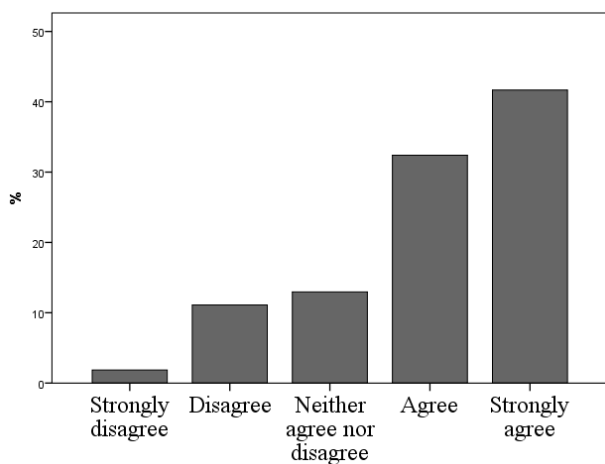

Figure 15. There are many obstacles for farmers to sell their products at a good price.

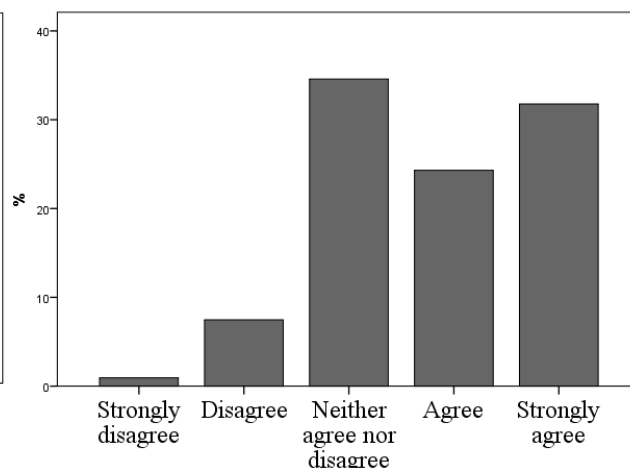

Figure 16. People who engage in other economic activities rather than agriculture have better opportunities than farmers do.

For changes in perceptions of farmers, they were also asked: “Do farmer’s perceptions depend on 1) the negotiation type, 2) his education level and 3) his buyer?”

Some research has focused on contract farming and type of contacts SMFs; this study included the negotiation type, which was classified as follows:

1. written contract
2. verbal contract

3. no contract

In spite of empirical evidence of the importance of these aspects, there were no differences in terms of perceptions. Regardless of farmers' types of contract, their perceptions on all statements were the same (Table 23).

Table 23. Farmers' perceptions on fairness statements by negotiation type\*

	S1	S2	S3	S4
Chi-square	1.763	.770	3.381	.215
Sig	.414	.680	.184	.898

\* Kruskal-Wallis test; grouping variable: negotiation type

Education level was classified as:

1. Incomplete elementary school (less than 6 years)
2. Complete elementary school (6 years)
3. Incomplete high school (between 6 and 11 years)
4. Complete high school (11 years)
5. Higher education (university, technical diploma)

Education is one of the fundamental needs for development, and educational level of farmers is often low in developing countries—La Fortuna is no exception. However, education was only significant for S2 (Table 24).

Table 24. Farmers perception on fairness statements by education level\*

	S1	S2	S3	S4
Chi-square	1.972	12.591	5.064	6.208
Sig	.741	.013	.281	.184

\* Kruskal-Wallis test; grouping variable: education level

Farmers with higher education are the ones with worst perceptions about whether payments farmers receive are enough to provide their families with good opportunities. Farmers with the lowest education level had the second worst perception of this statement. On the other hand, farmers with incomplete high school education had better perceptions

Higher education means that farmers must leave their hometown in La Fortuna and communicate with people from different regions and other professions. Therefore, they are more aware of different standards of living outside rural areas, which can influence their negative opinion on payments farmers receive and whether these are enough to access a better standard of living.

The least-educated farmers were the second group in terms of disagreement with S2. Although farmers may have a low level of education, their feeling about prices was similar to the most educated group, which could be a result of either interaction among farmers, influences of their family members or other variables not included in this research. Further research on this topic would be recommended since it may affect other aspects of farmers' perceptions and adoption of Fairtrade (or other) certification programs, especially when farmers have low education level.

Different types of buyers were classified as follows:

1. Hotels/restaurants
2. Supermarkets or grocery stores.
3. Factories (packing companies).
4. Intermediaries
5. Farmers' market or street sales

Empirical data show that farmers did have different perceptions on fairness depending on the type of buyer they reported having; see Table 25.

Table 25. Farmers perception on fairness by type of buyer\*

	S1	S2	S3	S4
Chi-square	10.484	15.276	9.875	1.681
Sig	.033	.004	.043	.794

\*Kruskal-Wallis test; grouping variable: type of buyer

Farmers who sold directly to a hotel/restaurant had a better perception about price fairness, followed by those who sold directly to the final consumer, either in farmers' markets or in street sales (Figure 18). Farmers who sold their products to intermediaries or factories mostly disagreed with the statement that the price of agricultural products is fair; farmers who sold to factories had the lowest perception of fairness of the prices they receive.

Farmers who sold directly to restaurants or to the final consumer reported higher prices, while those selling to either hotels/restaurants or in farmers' markets or street sales also reported the highest prices, but there were significant differences in the prices paid to farmers, dependent on the type of buyer; consequently, farmers' perceptions were also significantly different.

There was also a negative perception on how fair prices were for those who sold directly to supermarkets: in-depth interviews revealed that "farmers can see the high difference in prices there is from the price they sold their produce and the price supermarkets charge for the same product." The price gap was easier to see in this case (Figures 17-20).

With reference to whether payments were enough for farmers to provide good opportunities to their families (S2) (Figure 17), sellers to hotels/restaurants had the best perception, while those who sold to factories had the worst. Some 50.9% of farmers have a negative perception in this regard (strongly disagree or disagree), while 21.3% either strongly agreed or agreed.

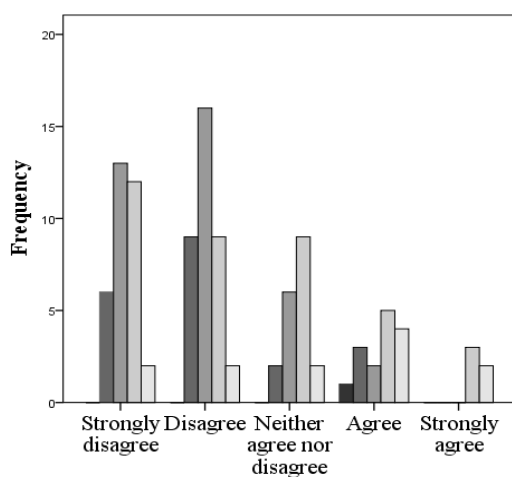

Figure 18. Price of agricultural products is fair, by type of buyer

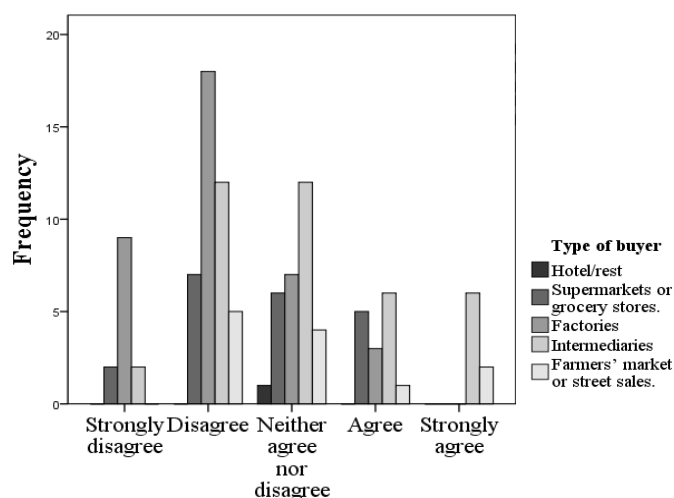

Figure 17. Payments farmers receive are enough to provide their families with good opportunities, by type of buyer

Those who encountered fewer obstacles to sell their products are once again farmers who sold to hotel/restaurants, while those who encountered more obstacles sold to factories; 74.1% of farmers had a negative perception of this variable, meaning they encounter many obstacles to market access at good prices. However, there are no differences according to the type of buyer.

The overall perspective on obstacles for SMFs to access the market is that most farmers consider there are many obstacles to selling agricultural products at good prices. Since smallholders mentioned in the pilot interviews that they can often sell all of their products most of the time but at very low prices (far below their average costs), this question was revisited and market access was accompanied by good prices so that farmers could consider the market as a profitable one, a “good opportunity,” as they often mentioned in interviews.

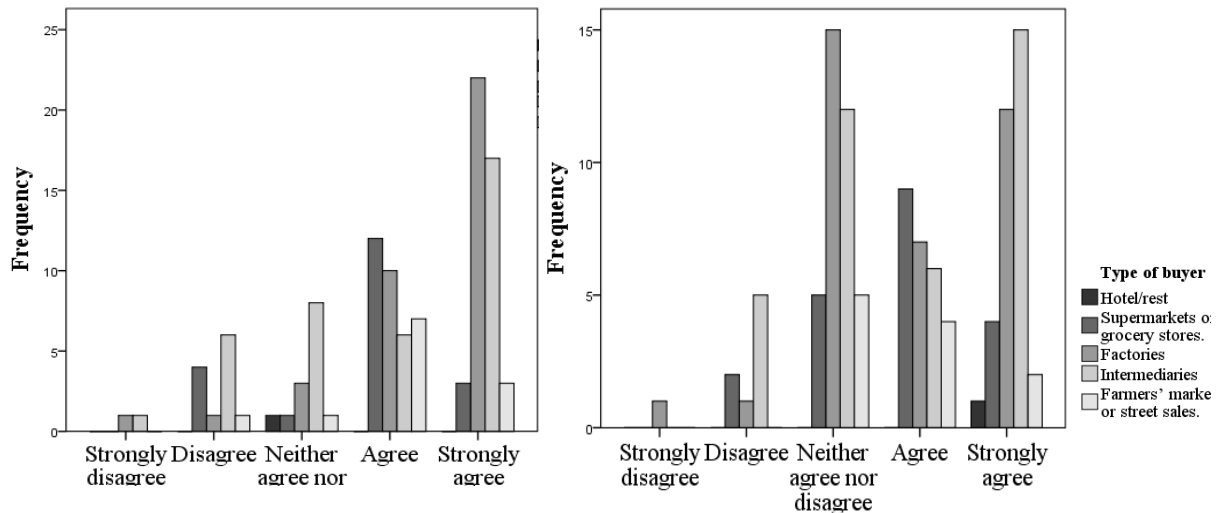

Figure 20. There are many obstacles for farmers to sell their products at a good price by type of buyer

Figure 19. People who engage in other economic activities rather than agriculture have better opportunities than farmers do by type of buyer.

From the consumers' perspective, 38% do not consider sustainability when selecting a tourist destination. Most tourists (75%) said they were willing to pay more so that their experience pays back to the host community. Average prices per meal tended to be in the two lower price categories: 74% of consumers paid less than \$20 per meal (Table 26).

Table 26. Average price paid by tourists per person per meal in La Fortuna, Costa Rica (October 2015–February 2016)

Payments	Frequency	Percentage (%)	Cumulative Percent (%)
Less than \$10	22	27.5	27.5
\$10 to \$19	37	46.3	73.8
\$20 to \$29	16	20.0	93.8
More than \$30	5	6.3	100.0
Total	80	100	

Most tourists confirmed they are willing to pay more for organic food (Table 27), but 93% would pay less than 20% of the current price.



Table 27. Willingness to pay for organic food in La Fortuna, Costa Rica, (October 2015–February 2016)

Additional payments	Frequency	Percentage (%)	Cumulative Percent (%)
Less than 10%	30	54	54
10 to 19%	22	39	93
20 to 29%	2	4	96.4
30 to 39%	2	4	100
Total	56	100	

If we consider general percentages, including those who said they would not pay more for organic food, 37.5% would pay less than 10%, 27.5% would pay from 10 to 19% more and only 2.5% would pay from 20 to 29%; the other 2.5% would pay from 30 to 39% more.

#### 6.4 Conclusion

This research provides a bottom-up perspective of small and medium farmers and how they perceive not only prices but also the comparative opportunities they have depending on agriculture as their main source of income.

Farmers thought agricultural prices too low compared to their costs and risks—64% considered prices unfair. Perceptions on obstacles to selling their produce at a good price were also negative. There were neither significant differences in perceptions of fairness of prices dependent on education of farmers or the type of negotiation; however, there were differences according to type of buyer. The only question in which there were no differences dependent on the type of buyer was S4, that people who engage in other economic activities provide better opportunities than agriculture.

From the consumer side, in a destination already considered expensive, most were willing to pay slightly higher prices (less than 20% more); if they could be sure this price premium would be received by farmers, probably most consumers would be willing to participate in a sustainable destination strategy. However, this entails certification or branding systems so that consumers trust the supply chain of the product they would be willing to pay more.

Since there is a possibility to increase meal prices by a small margin (20%), it would be imperative to promote direct selling in order to ensure higher prices for the farmers than they would receive from intermediaries.

#### 6.5 Recommendations

Results from this research provide an impression of tourists' willingness to pay for sustainable experiences and organic food; however, these results are not representative for the

region due to sample size; and therefore further research on this topic is needed for a more conclusive statement regarding willingness to pay for sustainable options.

A more in-depth research and analysis worldwide on consumers choices could predict sustainability trends in tourism. Market research would be useful to private companies and public institutions to take advantage of consumers' wants and needs and therefore target their demands through sustainable options—not solely of food but the entire tourist experience.

To improve the fair price estimation, some other financial variables could be included, such as national-scale data regarding a consumer price index (CPI) for sensitivity analysis of inflation rates. Another important input for fair price estimation could be price transmission analysis of agrochemicals prices compared with agricultural product prices.

# 7. Sustainable supply chain selection: multi-criteria Fuzzy TOPSIS analysis in an agricultural-tourism framework

## 7.1 Introduction

Sustainability is particularly important in agribusinesses since agriculture and agriculture-related activities have proven to boost development for the rural poor (United Nations 2015). The analysis of sustainable supply chains (SSC) includes three-fold sustainability components and addresses supply chain (SC) competitiveness in order for businesses to remain in sustainable and profitable markets. This research addresses the analysis of relationships among stakeholders and decision makers.

Supply chain actors usually choose their partners based on a multi-criteria decision-making procedure. Several studies have focused on supplier selection and evaluation (Zou *et.al.* 2011, Lima-Junior and Carpinetti 2016, Amorima *et al.* 2015, Nekooie *et al.* 2015, Yuan *et al.* 2015); however, determinant factors for partner selection vary widely. It is common for these studies to focus on only one perspective—often the buyers’ perspectives, but sustainability demands shared information along supply chains (Seuring and Müller 2008), so actors’ requirements should be shared with upstream and downstream partners.

This research analyzes agricultural procurement in a tourist-centered region. By promoting local sourcing of agricultural products, the region can strive for sustainable tourism, which refers to the maximization of the contribution of tourists to local prosperity by reducing leakages, strengthening links between businesses and influencing levels of visitor spending by demand-sided policies (UNEP 2005).

Research was conducted in La Fortuna, San Carlos, Costa Rica, which is one of the most important tourist attractions in the country. Due to local ownership, predominance of small and medium businesses and local environmental policies, the region has potential for development as a sustainable destination (Matarrita-Cascante *et al.* 2010). However local supply of agricultural products is not the most common trading system (S. Canedo-Rivas 2012).

Since human judgments can be vague, especially related to preferences, crisp data cannot be precisely estimated by a numerical expression. Vague concepts such as the preferred attributes of supply chain partners can be better estimated through a linguistic expression of preferences and then translated to fuzzy numbers. In order to address the lack of local sourcing, a multi-criteria decision-making analysis was carried out through the Technique for Order of Preference by Similarity to Ideal Solution (TOPSIS). Viewpoints from the farmers’ perspectives and from buyers’ perspectives—for example, restaurants in La Fortuna—were estimated separately to address the lack of direct trading mechanisms among them.

In this sense, and in order to address this estrangement with local markets, research focuses on local small and medium farmers (SMFs), local restaurants and their selection of partners in a local supply chain. An evaluation of the perceptions of both parties provides insight for targeting gaps and explaining why these potential supply chain partners have faced difficulties in supply chain cooperation. The evaluation included experience and education of farmers as segmentation variables to address differences in closeness coefficients (CC) dependent on these.

## **7.2 Literature review**

### **Literature review on sustainable tourism**

International arrivals to Costa Rica have grown 800% in the past 30 years (ICT 2015); in 2015, tourism represented 5.3% of the country's gross domestic product (GDP), being one of the most dynamic sectors. The country's tourism is linked to natural beauty and biodiversity; Costa Rica has become a leader in ecotourism due to a series of characteristics and policies led by the Costa Rica Tourism Institute (ICT), created in 1955 (ICT 2016).

In Costa Rica, the development of sustainable practices for tourism has been conducted by the Certification for Sustainable Tourism Program (CST), which is managed by ICT, as a national initiative to promote sustainability. The CST is carried out by third-party audits that categorize and certify tourism-related businesses (CST 2013). CST is an important initiative in the country, certifying hotels, restaurants and tour operators, but it does not do regional certification. Therefore, backward linkages are not so predominantly considered, which would be vital for a regional holistic sustainability approach.

In November 2013, the general principles for destination certification were launched by the Global Sustainable Tourism Council (GSTC) and they include four pillars: 1) sustainable management, 2) social and economic, 3) cultural, and 4) environmental. These pillars are arranged in four main sections: 1) demonstrate sustainable tourism management, 2) maximize economic benefits to the host community and minimize negative impact, 3) maximize benefits to communities, visitors and culture; minimize negative impacts and 4) maximize benefits to the environment and minimize negative impacts (GSTC 2016). These sections and pillars are aligned with local sourcing and sustainability, especially from SMFs.

The GSTC concept of sustainable destination is aligned with the United Nations Millennium Development Goals, including poverty alleviation, gender equality, environmental sustainability and climate change. Maximum levels of cooperation among actors are needed for a local promotion of better development standards (GSTC 2016). These GSTC principles include backward linkages and community involvement, which are the main issues addressed in this research, particularly focusing on the presence of SMFs in local food supply chains.

## **Agriculture supply chain and organization of SMFs**

The inclusion of smallholders in chains has certainly created room for discussion about the implications and requirements for small farmers. Understanding small farmers and the behavior of their potential buyers is the basis for determining strategies to promote sustainable linkages, notwithstanding behavior of small farmers is dependent on risk aversion and, largely, on cultural factors (Debertin 2012).

Effective supply chain management is particularly important when dealing with fresh products, (Boehlje *et al.* 1995); however, many governments in developing countries have dismantled marketing boards that looked after smallholders' interests (Hellin *et al.* 2009). In Costa Rica's case, the agricultural sector has shifted from local development toward mass production for international markets with high value-added products, such as pineapples, mangos, citric juices and tubers, by companies that are mainly owned by international bodies (Fernández-Alvarado and Granados-Carvajal 2000).

When sourcing for high value-added food supply chains, incentives for coordination become important as product requirements increase (Gulati *et al.* 2005). In the case of agriculture, without the possibility to verify quality characteristics at the point of sale, buyers will not be able to offer a premium price for higher quality products.

Usually, processors get involved in contract farming or other coordination mechanisms when they need a more reliable supply of raw materials than what they can otherwise easily obtain. These coordination mechanisms create risk and information-sharing strategies in which co-dependency pushes both sides (buyers and sellers) to coordinate and comply with established rules for gaining shared benefits—win-win strategies.

Vertical coordination, contract farming or joint collaboration are proposed techniques for increasing trust and confidence among actors. According to Gulati *et al.*, (2005), "Each of these forms of arrangement embodies different ways to share risks, costs and benefits of high value commodity supply chains." Nonetheless, coordinating with SMFs is still a challenge in food supply chains.

Modern food systems are close to be monopsony markets (Pingali *et al.* 2005) and although the number of potential suppliers (small farmers) is large, transaction costs from working with large numbers of smallholders are also high (Haynes 2000). These include bureaucratic costs, opportunity costs of time used to communicate and coordinate with a large number of small farmers, costs of establishing and monitoring long-term contracts, screening costs linked to uncertainties about the reliability of suppliers as well as product quality and transfer costs of legal or physical constraints.

Reardon and Berdegué (2002) studied the supermarket sector in several countries in Latin America, including Costa Rica. Their findings suggest that quality standards, safety standards,

packing, volumes, consistency and payment practices are still important challenges for farmers of the region. Accordingly, they propose that development agencies need to take into account that farmers have to gear up to compete in the new markets led by supermarkets. Local markets with lower standards are disappearing and the distance between international standards and local markets are also diminishing.

Torres and Momsen (2004) identified factors that restrict smallholders' participation in linkage generation through tourism supply chains. These factors were obtained from previous empirical studies (Andreatta 1998; Ashley and Jones 2001; Bélisle 1983, 1984a, 1984b; Bowen, Cox and Fox 1991; Carter 1987; Doxey and Associates 1971; ECE/FAO 1982; Goffe 1975; Gomes 1993; Gooding 1971; McElroy and Albuquerque 1990; Miller 1985); Milne 1992); Momsen 1972, 1973), 1986, 1998, 2002; Monk and Alexander 1986; O'Ferral 1991; Pattullo 1996; Pizam and Sussmann 1995; Saville 2001; Sharkey and Momsen 1995; Shaw and Williams 1994; Telfer 1996; Maldonado 1997; Torres 2000; Turner and Ash 1975; Tyrakowski 1986; USAID 1984; Weaver 1991). The factors were divided in three categories: supply (production related), demand and market.

1. Supply (production related):

- Lack of partnership development
- Lack of sufficient, consistent and guaranteed quantity of locally produced food
- Inadequate quality of local production
- High prices of locally produced foods
- Local farming systems' small economies of scale
- Poor growing conditions
- Nature of existing local farming systems
- Lack of capital, investment and credit
- Technological restrictions
- Farm labor deficit attributable to competition with tourism sector
- Smallholders cannot comply with quality and control requirements

2. Demand side:

- Foreign-owned, large and high-end hotel preference for processed and imported foods
- Immature tourism industry preference for imported and internally supplied foods
- Certain types of tourist (mass and foreign) preferences for imported and/or home-country foods
- Tourist and chef mistrust of local food owing to sanitation, hygiene and health concerns
- Foreign or internationally trained chef preference for imported foods

3. Market:

- Failure to promote local foods

- Poor/inadequate transportation, storage, processing and marketing infrastructure
- Mistrust and lack of communication/information exchange between farmers, suppliers and tourism industry
- Entrenched monopoly marketing networks that prevent local farmer access
- Corrupt local marketing networks that limit local producer access
- Bureaucratic obstacles and informal nature of local farming operations

Other authors such as UNEP (2011), Bohdanowicz *et al.* (2001) and CREST (2012), have focused on factors for success of linkages between agriculture and tourism and divided enabling factors into those related to the small-scale farmers (supply side), their characteristics and those from the demand side (tourists needs).

Reardon *et al.* (2005) studied the linkages between small-scale farmers and wholesalers in Latin America in supermarket supply chains. Decisions to participate in the supply chain were analyzed from two perspectives: supply (wholesalers and farmers) and demand (retailers). Capacities, costs, managerial skills, quality of the product and threshold firm size are the main factors considered by retailers. Farmers and wholesalers consider the price premium, the cost of technological change and the cost of doing business (transaction costs) with supermarkets and the market risk when dealing with supermarkets,

Van-der-Straaten (2002) analyzed three European case studies of community improvement through tourism and concluded appropriate marketing is a key to successful strategies. de Janvry and Sadoulet (2005) also studied factors of success when including smallholders into development of high value crops and specified sectorial policies, entrepreneurial competence, coordination among stakeholders, prior institutional development and technical upgrading.

Pingali *et al.* (2005) suggest that smallholders face two main difficulties in adapting to current food systems; 1) their ability to commercialize from production systems that are usually semi-subsistence and 2) the crop or enterprise of choice. Farmers cannot shift abruptly from one crop to another; they are dependent on weather conditions and know-how of farming conditions.

Fleischer and Tchetchik, (2005) studied working farms that mix agriculture and tourism, concluding how visitors do not value working farms; however, farms producing agricultural goods and having tourist services use their factors more efficiently than those managed by non-farmers.

Advantages for coordinating supply chains commonly include better prices, higher quality and safety standards, along with reduction of costs due to higher efficiency and reduction of losses (Van-der-Meer 2006); therefore, fresh product losses can be higher in the case of uncoordinated or poorly coordinated supply chains. From a general perspective, farmers'

characteristics and their market orientations are based on their resource base, their technology, risk factors, their perceptions of food security, size, power relationships they face and their linkage to institutions (Arias *et al.* 2013).

Gulati *et al.* (2005) identified factors or conditions that limit smallholders' participation in high value-added chains, mainly connected to their characteristics. Smallholders cannot comply with quality and control requirements or provide standardized products; they also have less market access due to lack of information and familiarity with the system.

Some of the most important constraints when working with small-scale farmers are the lack of knowledge of markets, lack of appropriate technologies or modern inputs and access to capital (to upgrade production). Scale, low quality and heterogeneity of products are also some of the problems small-scale farmers face when included in supply chains. In fact, they would rarely be included in supply chains were it not for support from traders and processors (Van-der-Meer 2006). Mutual trust between farmers and enterprises would reduce risks, and therefore costs; organization of farmers and effective leadership are crucial factor to overcoming weaknesses (Van-der-Meer 2006).

Henson *et al.* (2008) analyzed the possibilities and benefits of African smallholder participation in high value markets given that their inclusion is essential to development goals. Research in Mesoamerica suggests that evidence of benefits from farmer organization is more evident in the vegetable sector, where there are higher transaction costs, but it is very rare for smallholders to self-organize (Hellin *et al.* 2009).

There is a lack of consensus in determining success of interventions, but positive and negative effects of contract farming can be identified along the supply chain. Empirical research suggests, that neither the level nor the distribution of income will be improved for the poor unless they have improved access to assets such as land and education, which can make their primary asset, labor, more productive during the growth process (Norton *et al.* 2010).

### **7.3 Methods**

Fuzzy logic was developed by Zadeh (1965) and it is used specially when dealing with vague concepts (Guzmán and Castaño 2006), such as criteria for decision making that are not clear and are biased toward personal perspectives and past experiences.

Decision makers find it more convenient to express interval judgments rather than fixed value judgments due to the fuzzy nature of the comparison processes (Bozdağ *et al.*, 2003), and therefore vague concepts can be quantified via fuzzy logic. For this research, a fuzzy TOPSIS was carried out to optimize the selection of partners according to two actors of the supply chain—preferences of farmers and of restaurant managers.

An ordinary subset of A of a set U is determined by its indicator function, or characteristic function  $X_A(x)$  (Shepard 2005).



$$X_A(x) = \begin{cases} 1 & \text{if } x \in A \\ 0 & \text{if } x \notin A \end{cases} \quad (25)$$

By allowing variables to be in the interval [0.1] they are on a range from these two numbers rather than restricted to the two element set {0.1}. A fuzzy subset of a set U is a function  $A: U \rightarrow [0.1]$ . The following figure shows how each variable is explained by a triangular fuzzy number  $(a, b, c)$ .

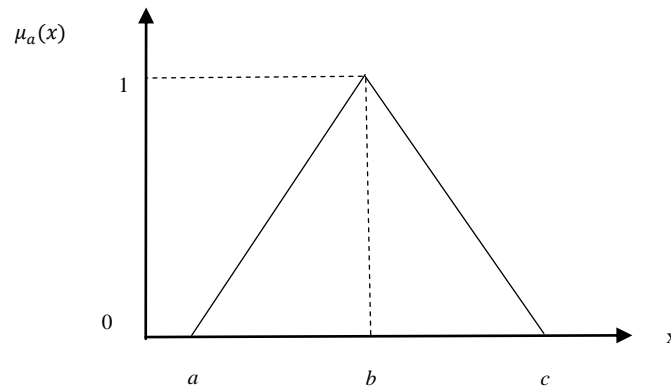

Figure 21. Membership function representation.

Source. Adapted from Ganga and Carpinetti, 2011

For a fuzzy set  $A: U \rightarrow [0.1]$  is called a membership function and the value  $\mu_a(x)$  is the degree of membership of  $u_a$  in the fuzzy set. Fuzzy sets analyze the varying degree to which cases belong to sets (Ragin 2000). In figure 1, values on the x-axis range from 0 to 10 and on the y-axis from 0 to 1; this measures the degree of membership of each x to a concept.

A fuzzy number is obtained from each variable's membership function  $\mu_a$  and it comes from the following equations (Zadeh 1965):

$$\mu_a(x) = \begin{cases} 0, & x \leq a \\ \frac{x-a}{b-a}, & a < x \leq b \\ \frac{c-x}{c-b}, & b < x \leq c \\ 0, & x > c \end{cases} \quad (26)$$

The distance between scores is the distance between the two triangular fuzzy numbers and it is determined by

$$d(\tilde{a}_1, \tilde{a}_2) = \sqrt{\frac{1}{3} [(a_1 - a_2)^2 + (b_1 - b_2)^2 + (c_1 - c_2)^2]} \quad (27)$$

The linguistic variables and their correspondent fuzzy numbers are presented in Table 28.

Table 28. Linguistic variables and their fuzzy values

Likert-scale linguistic variable		$a_i$	$b_i$	$c_i$
Weights	Alternative ranking			
Very important	Excellent	8	9	10
Important	Very good	6	7	8
Somewhat important	Good	4	5	6
Somewhat unimportant	Fair	2	3	4
Very unimportant	Poor	0	1	2

The relative importance of each criterion for decision makers when they choose a supply chain partner was obtained. This matrix shows the relative importance of each criterion. Criteria weighted by decision makers would be represented by, where  $DM$  = decision-makers and  $C$ = criteria.

$$\begin{matrix} & C_1 & \dots & C_j \\ DM_1 & & & \\ \vdots & & & \\ DM_k & & & \end{matrix} \left[ \begin{matrix} \\ \\ \\ \end{matrix} \right]$$

Likewise, decision makers characterize each alternative according to the same criteria. The entries of this matrix are  $x_{ij}^k$ , where  $k$  is the number of respondents,  $i$  is the number of alternatives and  $j$  is the number of criteria.

$$\begin{matrix} & A_1 & \dots & A_5 \\ DM_1 & \dots & DM_k & DM_1 & \dots & DM_k \\ \vdots & & & & & \\ C_j & & & & & \end{matrix} \left[ \begin{matrix} \\ \\ \\ \end{matrix} \right]$$

With the abovementioned matrix, a fuzzy aggregated matrix that groups each matrix was created using the following:

$$a_{ij} = \frac{1}{k} \sum_1^k a_{ij}^k, \quad b_{ij} = \frac{1}{k} \sum_1^k b_{ij}^k, \quad c_{ij} = \frac{1}{k} \sum_1^k c_{ij}^k \quad (28)$$

From these, the fuzzy aggregated matrix is constructed:

where  $\tilde{a}_{ij} = (a_{ij}, b_{ij}, c_{ij})$ .

$$D_{m \times n} = \begin{matrix} & C_1 & C_2 & C_3 & \dots & C_n \\ \begin{matrix} A_1 \\ A_2 \\ A_3 \\ \dots \\ A_m \end{matrix} & \left( \begin{matrix} \tilde{a}_{11} & \tilde{a}_{12} & \tilde{a}_{13} & \dots & \tilde{a}_{1n} \\ \tilde{a}_{21} & \tilde{a}_{22} & \tilde{a}_{23} & \dots & \tilde{a}_{2n} \\ \tilde{a}_{31} & \tilde{a}_{32} & \tilde{a}_{33} & \dots & \tilde{a}_{3n} \\ \dots & \dots & \dots & \dots & \dots \\ \tilde{a}_{m1} & \tilde{a}_{m2} & \tilde{a}_{m3} & \dots & \tilde{a}_{mn} \end{matrix} \right) \end{matrix}$$

A normalization of the fuzzy aggregated matrix was obtained by an R matrix.  $R = (r_{ij})$ . These entries are obtained from the following two equations:

$$r_{ij} = \left( \frac{a_{ij}}{c_j^*}, \frac{b_{ij}}{c_j^*}, \frac{c_{ij}}{c_j^*} \right), j \in B \quad (29)$$

$$r_{ij} = \left( \frac{a_j^-}{c_{ij}^*}, \frac{a_j^-}{b_{ij}^*}, \frac{a_j^-}{a_{ij}^*} \right), j \in C \quad (30)$$

where  $B$  represents the benefit criteria and  $C$  the cost criteria,

while  $r_{ij}$  represents the inputs of normalized decision – making matrix  $R$

$$c_j^* = \max_i c_{ij} \text{ if } j \in B \quad (31)$$

$$a_j^- = \min_i a_{ij} \text{ if } j \in C \quad (32)$$

The responses of weight were also aggregated in the following way:

$$\left( \begin{array}{ccccccccc} (w_{11}^1, & w_{12}^1, & w_{13}^1), & (w_{21}^1, & w_{22}^1, & w_{23}^1), & (w_{31}^1, & w_{32}^1, & w_{33}^1), & \dots, & (w_{j1}^1, & w_{j2}^1, \\ & & w_{j3}^1) & & & & & & & & & & \\ (w_{11}^3, & w_{12}^3, & w_{13}^3), & (w_{21}^3, & w_{22}^3, & w_{23}^3), & (w_{31}^3, & w_{32}^3, & w_{33}^3), & \dots, & (w_{j1}^3, & w_{j2}^3, \\ & & w_{j3}^3) & & & & & & & & & & \\ \vdots & & & & & & \ddots & & & & & & \vdots \\ (w_{11}^k, & w_{12}^k, & w_{13}^k), & (w_{21}^k, & w_{22}^k, & w_{23}^k), & (w_{31}^k, & w_{32}^k, & w_{33}^k), & \dots, & (w_{j1}^k, & w_{j2}^k, \\ & & w_{j3}^k) & & & & & & & & & & \end{array} \right)$$

Then, for each criterion, the aggregated weight per criteria was estimated by

$$w_{j1} = \frac{1}{k} \sum_{k=1}^k w_{1j}^k, \quad w_{j2} = \frac{1}{k} \sum_{k=1}^k w_{2j}^k, \quad w_{j3} = \frac{1}{k} \sum_{k=1}^k w_{3j}^k, \quad (33)$$

The weighted normalized fuzzy decision matrix was created by multiplying the normalized aggregate fuzzy decision matrix by the previously calculated weight per criteria in the following way:

Criteria	$A_1$		$A_5$
$C_1$	$\tilde{a}_{11} * \hat{w}_{11}$	...	$\tilde{a}_{51} * \hat{w}_{51}$
$C_2$	$\tilde{a}_{12} * \hat{w}_{12}$	...	$\tilde{a}_{52} * \hat{w}_{52}$
$\vdots$	$\vdots$	$\vdots$	$\vdots$
$C_j$	$\tilde{a}_{1j} * \hat{w}_{1j}$	...	$\tilde{a}_{5j} * \hat{w}_{5j}$

The multiplication of fuzzy numbers was done by

$$(a_1, b_1, c_1) \odot (a_2, b_2, c_2) \simeq (a_1 * a_2, b_1 * b_2, c_1 * c_2) \quad (34)$$

The Fuzzy Positive Ideal Solution (FPIS =  $A^+$ ) and Fuzzy Negative Ideal Solution (FNIS =  $A^-$ ) were obtained by

$$A^+ = \tilde{a}_{ij}^* = \{\tilde{a}_1^*, \tilde{a}_2^*, \dots, \tilde{a}_n^*\} \quad (35)$$

$$A^- = \tilde{a}_{ij}^- = \{\tilde{a}_1^-, \tilde{a}_2^-, \dots, \tilde{a}_n^-\} \quad (36)$$

Then the estimation of distances from  $A^+$  and  $A^-$  and each of the weighted normalized fuzzy decision matrix entries were estimated by the distance parameter:

$$d_i^* = d(\tilde{a}_{ij}, \tilde{a}_{ij}^*) = \sqrt{\frac{1}{3}[(a_1 - a^*)^2 + (b_1 - b^*)^2 + (c_1 - c^*)^2]} \quad (37)$$

$$d_i^- = d(\tilde{a}_{ij}, \tilde{a}_{ij}^-) = \sqrt{\frac{1}{3}[(a^- - a_1)^2 + (b^- - b_1)^2 + (c^- - c_1)^2]} \quad (38)$$

Therefore, we get six distances—from each alternative to the FPIS and from each alternative to the FNIS. Finally, the CC is estimated in order to obtain the alternative with the highest closeness coefficient that includes the smallest distance from  $A^+ = (1, 1, \dots, 1)$  and the largest difference from the worst possible solution  $A^- = (0, 0, \dots, 0)$ .

$$CC_i = \frac{d_i^-}{d_i^- + d_i^*} \quad (39)$$

## 7.4 Numerical implementation

SMFs (108) as well as restaurant managers (30) were interviewed and were asked to rank, according to a five-point Likert scale the importance of each of the selected variables as well as a ranking of how well their actual supply chain partner performs in terms of those variables. The transformation of the Likert scale was done in a 10-point fuzzy distribution, from 1 to 10. These variables were transformed to triangular fuzzy numbers that describe the membership function to the specific criteria.

All farmers approached were willing to collaborate while roughly 50 percent of 63 restaurants contacted responded. Interviews were carried out personally in both cases, although for most restaurants, a previous contact was established either by email or by phone. Both parts rated the importance of the criteria ( $C_i$ ), mentioned the trading alternatives they use ( $A_i$ ) and rated them according to their experiences.

According to the previous literature review, these were the variables considered for analysis:

1. Quantity sold either to regional, national or international buyers ( $C_1$ ).
2. Transportation system ( $C_2$ ).
3. Price: colons (national currency) ( $C_3$ ).
4. Quality: perception of product quality ( $C_4$ ).
5. Education of decision makers: education includes formal education as well as informal education—formal school system and training courses attended ( $C_5$ ).
6. Distance from supply chain partners ( $C_6$ ).
7. Years in business: as a proxy for performance, trust and managerial skills, assuming that either a farmer or a hotel/ restaurant with good managerial skills and general performance could gain trust from their supply chain partners and strengthen their market knowledge ( $C_7$ ).
8. Transparency of transactions: as proxy of risk aversion ( $C_8$ ). Risk is defined as the probability that income will fall below a predetermined disaster level (de Janvry and Sadoulet 1995), therefore this transparency statement shows how often farmers prefer to linger with one buyer rather than searching for other risky options despite fact that this buyer does not comply with negotiation terms.
9. Associative culture ( $C_9$ ).
10. Water and waste management ( $C_{10}$ ).
11. Organic production and access ( $C_{11}$ ).
12. Access to irrigation systems ( $C_{12}$ ).

Decision makers (DM) can buy or sell their products in the following way, which will be considered as the alternatives.

Farmers:

1. directly sold to restaurants ( $A_1$ )
2. supermarkets or other retail enterprises ( $A_2$ )
3. packing company ( $A_3$ )
4. intermediary ( $A_4$ )
5. directly to final consumer ( $A_5$ )

Restaurants:

1. directly from farmers ( $A_1$ )
2. from intermediaries ( $A_2$ )
3. from a mixed supply: farmers and intermediaries ( $A_3$ )

Once general results were obtained, we organized a workshop for data validation and in-depth understanding of some results; farmers as well as restaurant owners or managers were invited to participate.

## 7.5 Results and discussion

Data was collected from October 2015 through January 2016 from both DM; weights obtained from equation 9 are shown in the Table 29. While restaurants included a new criterion— consistency ( $C_{13}$ ), farmers included only those previously mentioned. For restaurants, the most important criteria were price ( $C_3 = 0.72, 0.85, 0.95$ ), quality ( $C_4 = 0.75, 0.85, 0.96$ ) and consistency ( $C_{13} = 0.77, 0.87, 0.97$ ). For farmers the most important criteria were price ( $C_3 = 0.67, 0.77, 0.87$ ), quality ( $C_4 = 0.62, 0.72, 0.82$ ), quantity ( $C_1 = 0.59, 0.69, 0.79$ ) and transparency of transactions ( $C_8 = 0.57, 0.67, 0.77$ ).

Transparency ( $C_8$ ) is important for farmers; but they often reported that price is only known the day before the transaction or even when the buyer arrives at the farm gate. Regardless, farmers' perception of transparency is not affected by the fact that they do not negotiate the price in advance; most of them are price takers since prices are fully determined by buyers.

Table 29. Aggregated weights for decision makers, La Fortuna, 2015

Criteria	Restaurants		Farmers	
	(a,b,c)	Relative importance	(a,b,c)	Relative importance
C1	(0.66, 0.76, 0.83)	0.09	(0.59, 0.69, 0.79)	0.10
C2	(0.66, 0.76, 0.86)	0.09	(0.56, 0.66, 0.76)	0.09
C3	<b>(0.72, 0.85, 0.95)</b>	0.10	(0.67, 0.77, 0.87)	0.11
C4	(0.75, 0.85, 0.96)	0.10	(0.62, 0.72, 0.82)	0.10
C5	(0.32, 0.42, 0.52)	0.05	(0.38, 0.48, 0.58)	0.07
C6	(0.36, 0.46, 0.56)	0.06	(0.50, 0.60, 0.70)	0.09
C7	(0.44, 0.54, 0.64)	0.06	(0.45, 0.55, 0.65)	0.08
C8	(0.69, 0.79, 0.89)	0.09	(0.57, 0.67, 0.77)	0.10
C9	(0.34, 0.44, 0.54)	0.05	(0.28, 0.38, 0.48)	0.06
C10	(0.49, 0.59, 0.69)	0.07	(0.39, 0.49, 0.59)	0.07
C11	(0.53, 0.63, 0.73)	0.08	(0.33, 0.43, 0.53)	0.06
C12	(0.31, 0.41, 0.51)	0.05	(0.45, 0.55, 0.65)	0.07
C13	(0.77, 0.87, 0.97)	0.1	NA	NA

Farmers were relatively less interested in organic production ( $C_{11}$ ) than restaurants; there was no translation of organic needs from restaurants to possible local suppliers, meaning poor information flow from the restaurants' needs to farmers. Farmers did consider distance ( $C_6$ ) as a relatively important factor (0.5, 0.6, 0.7) while restaurants did not (0.36, 0.42, 0.56), mainly because most farmers do not have their own means of transportation, depending on others to sell their produce.

Individual matrices of rankings of alternatives were aggregated in Table 30 by estimations from equation 33.

Table 30. Aggregated rankings of criteria and alternatives. La Fortuna, 2015

DM	A	C1	C2	C3	C4	C5	C6	C7
R	A1	(0.79, 0.89, 1.00)	(0.79, 0.89, 1.00)	(0.76, 0.88, 1.00)	(0.79, 0.89, 1.00)	(0.75, 0.88, 1.00)	(0.47, 0.53, 0.61)	(0.78, 0.89, 1.00)
	A2	(0.68, 0.79, 0.89)	(0.68, 0.78, 0.89)	(0.69, 0.81, 0.93)	(0.66, 0.77, 0.88)	(0.48, 0.61, 0.73)	(0.68, 0.81, 1.00)	(0.76, 0.87, 0.98)
	A3	(0.69, 0.80, 0.90)	(0.60, 0.71, 0.81)	(0.61, 0.72, 0.84)	(0.69, 0.80, 0.90)	(0.50, 0.63, 0.75)	(0.65, 0.77, 0.93)	(0.57, 0.68, 0.79)
F	A1	(0.65, 0.76, 0.87)	(0.75, 0.88, 1.00)	(0.24, 0.36, 0.49)	(0.80, 0.90, 1.00)	(0.50, 0.63, 0.75)	(0.56, 0.63, 0.74)	(0.73, 0.85, 0.97)
	A2	(0.78, 0.89, 1.00)	(0.55, 0.68, 0.80)	(0.19, 0.32, 0.44)	(0.40, 0.50, 0.60)	(0.75, 0.88, 1.00)	(0.58, 0.67, 0.79)	(0.58, 0.72, 0.83)
	A3	(0.67, 0.78, 0.89)	(0.66, 0.79, 0.91)	(0.24, 0.36, 0.48)	(0.51, 0.61, 0.71)	(0.60, 0.73, 0.86)	(0.64, 0.74, 0.89)	(0.63, 0.75, 0.87)
	A4	(0.64, 0.75, 0.86)	(0.70, 0.81, 0.95)	(0.28, 0.40, 0.53)	(0.47, 0.57, 0.67)	(0.54, 0.66, 0.79)	(0.64, 0.75, 0.90)	(0.58, 0.70, 0.82)
	A5	(0.55, 0.66, 0.77)	(0.44, 0.56, 0.69)	(0.76, 0.87, 1.00)	(0.58, 0.68, 0.78)	(0.64, 0.76, 0.89)	(0.69, 0.82, 1.00)	(0.76, 0.88, 1.00)

DM	A	C8	C9	C10	C11	C12	C13
R	A1	(0.8, 0.9, 1.00)	(0.79, 0.89, 1.00)	(0.75, 0.88, 1.00)	(0.77, 0.88, 1.00)	(0.71, 0.86, 1.00)	(0.80, 0.90, 1.00)
	A2	(0.67, 0.77, 0.87)	(0.62, 0.73, 0.83)	(0.45, 0.66, 0.79)	(0.39, 0.51, 0.69)	(0.52, 0.66, 0.81)	(0.20, 0.30, 0.40)
	A3	(0.69, 0.79, 0.89)	(0.67, 0.78, 0.89)	(0.35, 0.48, 0.60)	(0.42, 0.54, 0.65)	(0.48, 0.62, 0.76)	(0.40, 0.50, 0.60)
F	A1	(0.80, 0.90, 1.00)	(0.75, 0.88, 1.00)	(0.36, 0.49, 0.65)	(0.33, 0.39, 0.65)	(0.36, 0.55, 0.73)	(0.50, 0.75, 1.00)
	A2	(0.56, 0.66, 0.76)	(0.65, 0.78, 0.90)	(0.54, 0.71, 0.87)	(0.54, 0.71, 0.87)	(0.07, 0.25, 0.43)	(0.10, 0.35, 0.60)
	A3	(0.47, 0.57, 0.67)	(0.62, 0.74, 0.87)	(0.67, 0.84, 1.00)	(0.67, 0.84, 1.00)	(0.37, 0.56, 0.74)	(0.50, 0.75, 1.00)
	A4	(0.33, 0.43, 0.53)	(0.52, 0.65, 0.77)	(0.55, 0.71, 0.88)	(0.55, 0.71, 0.88)	(0.31, 0.49, 0.68)	(0.51, 0.66, 0.91)
	A5	(0.64, 0.74, 0.84)	(0.58, 0.71, 0.83)	(0.53, 0.69, 0.96)	(0.53, 0.69, 0.86)	(0.64, 0.82, 1.00)	(0.38, 0.63, 0.88)

The weighted normalized fuzzy decision matrix was obtained by equation 3.33 (Table 31). These results are also shown as a graphic representation (Table 32) in order to compare scattering of responses by criteria and by alternative.

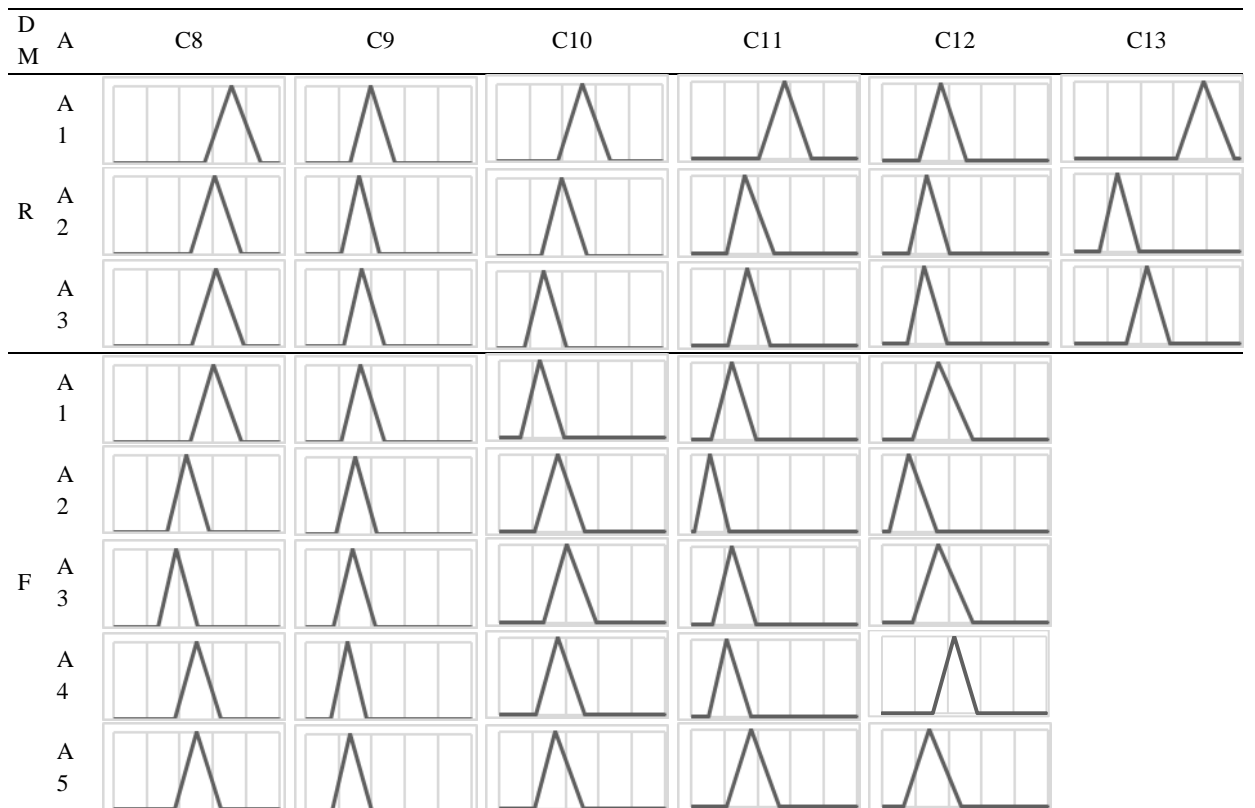
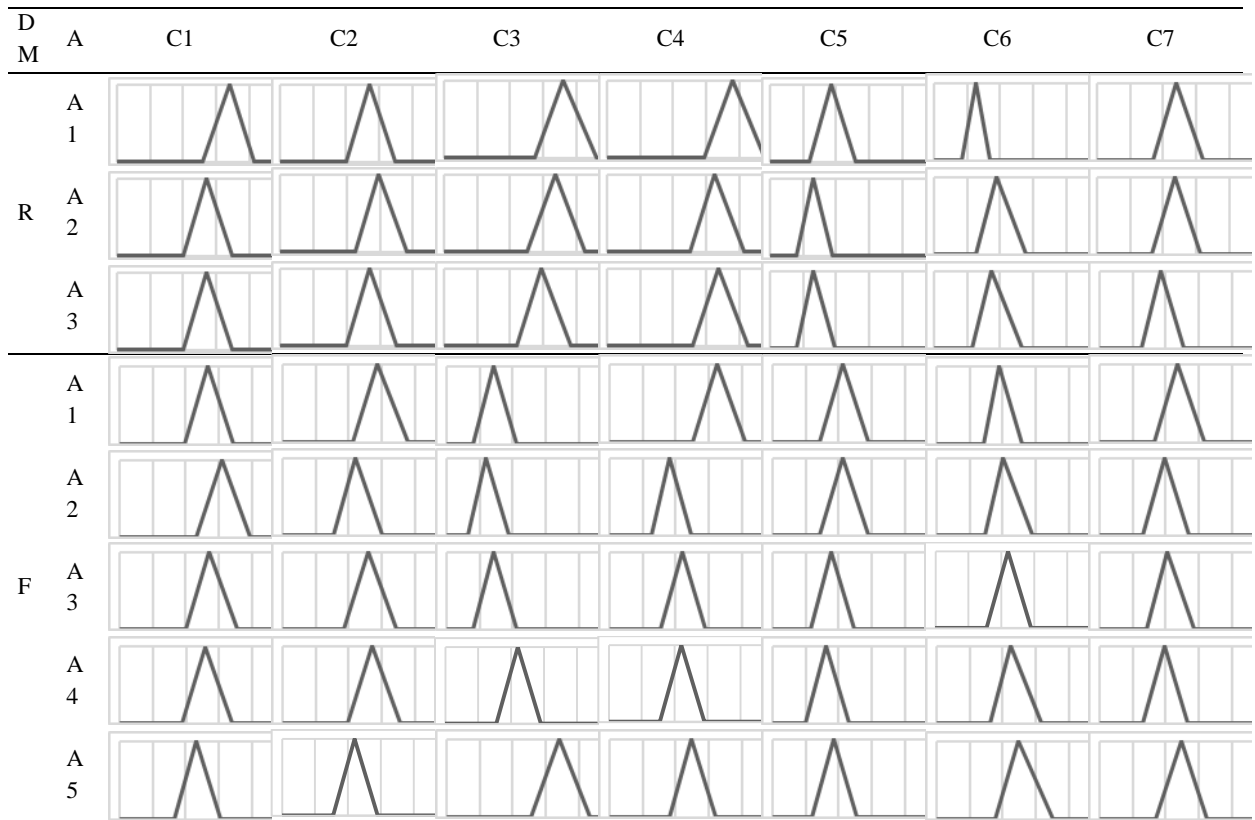

Table 31. Weighted normalized fuzzy decision matrix, La Fortuna, 2015

DM	A	C1	C2	C3	C4	C5	C6	C7
R	A1	(0.52, 0.68, 0.83)	(0.52, 0.68, 0.86)	(0.55, 0.72, 0.92)	(0.59, 0.76, 0.95)	(0.24, 0.37, 0.52)	(0.17, 0.25, 0.34)	(0.34, 0.48, 0.64)
	A2	(0.45, 0.60, 0.74)	(0.45, 0.59, 0.76)	(0.50, 0.67, 0.85)	(0.50, 0.65, 0.83)	(0.16, 0.26, 0.38)	(0.25, 0.38, 0.56)	(0.33, 0.47, 0.63)
	A3	(0.46, 0.61, 0.75)	(0.40, 0.54, 0.70)	(0.44, 0.59, 0.77)	(0.52, 0.67, 0.85)	(0.16, 0.26, 0.39)	(0.23, 0.35, 0.53)	(0.25, 0.37, 0.51)
F	A1	(0.39, 0.53, 0.69)	(0.42, 0.57, 0.76)	(0.16, 0.28, 0.42)	(0.50, 0.65, 0.82)	(0.19, 0.30, 0.43)	(0.28, 0.38, 0.52)	(0.33, 0.47, 0.63)
	A2	(0.46, 0.62, 0.79)	(0.31, 0.44, 0.60)	(0.13, 0.24, 0.38)	(0.25, 0.36, 0.49)	(0.28, 0.42, 0.58)	(0.29, 0.40, 0.58)	(0.26, 0.39, 0.54)
	A3	(0.40, 0.54, 0.71)	(0.37, 0.52, 0.69)	(0.16, 0.28, 0.42)	(0.31, 0.44, 0.58)	(0.23, 0.35, 0.49)	(0.32, 0.45, 0.63)	(0.28, 0.41, 0.57)
	A4	(0.38, 0.52, 0.68)	(0.39, 0.54, 0.71)	(0.19, 0.31, 0.46)	(0.29, 0.41, 0.55)	(0.20, 0.32, 0.46)	(0.32, 0.45, 0.63)	(0.26, 0.39, 0.53)
	A5	(0.33, 0.46, 0.61)	(0.24, 0.37, 0.52)	(0.51, 0.68, 0.87)	(0.36, 0.49, 0.64)	(0.24, 0.37, 0.51)	(0.35, 0.49, 0.70)	(0.34, 0.49, 0.65)

DM	A	C8	C9	C10	C11	C12	C13
R	A1	(0.55, 0.71, 0.89)	(0.27, 0.39, 0.54)	(0.37, 0.52, 0.69)	(0.41, 0.56, 0.73)	(0.22, 0.35, 0.51)	(0.62, 0.78, 0.97)
	A2	(0.46, 0.61, 0.77)	(0.21, 0.32, 0.45)	(0.27, 0.39, 0.55)	(0.21, 0.32, 0.50)	(0.16, 0.27, 0.41)	(0.15, 0.26, 0.39)
	A3	(0.47, 0.62, 0.79)	(0.23, 0.34, 0.48)	(0.17, 0.28, 0.42)	(0.22, 0.34, 0.48)	(0.15, 0.25, 0.39)	(0.31, 0.44, 0.58)
F	A1	(0.46, 0.60, 0.77)	(0.21, 0.33, 0.48)	(0.13, 0.24, 0.39)	(0.12, 0.24, 0.39)	(0.18, 0.34, 0.55)	
	A2	(0.32, 0.44, 0.58)	(0.18, 0.30, 0.43)	(0.21, 0.35, 0.52)	(0.02, 0.11, 0.23)	(0.04, 0.16, 0.33)	
	A3	(0.27, 0.38, 0.51)	(0.17, 0.28, 0.42)	(0.27, 0.41, 0.59)	(0.13, 0.24, 0.39)	(0.18, 0.34, 0.55)	
	A4	(0.19, 0.29, 0.41)	(0.15, 0.25, 0.37)	(0.22, 0.35, 0.52)	(0.10, 0.21, 0.36)	(0.14, 0.30, 0.50)	
	A5	(0.37, 0.50, 0.65)	(0.16, 0.27, 0.40)	(0.21, 0.34, 0.51)	(0.21, 0.36, 0.53)	(0.13, 0.28, 0.48)	

Table 32. Graphic representation of weighted normalized fuzzy decision matrix, La Fortuna, 2015



Horizontal distances under each curve of the above figure determine the deviation from mean responses; for example, for C6, farmers' responses for alternative 1 were close together, while for alternative 5, responses are more scattered.

Estimation of the FPIS and FNIS were obtained by equations 35 and 36—estimating the distance between the weighted normalized fuzzy decision matrix and  $A^+$  and  $A^-$ . The CC for each alternative were estimated through equation 39 (Table 33).

Table 33. FNIS, FPIS and CC for each alternative and decision maker, La Fortuna, 2015

DM	A	FPIS	FNIS	CC
Restaurants	A1	5.96	7.52	0.56
	A2	7.29	6.11	0.46
	A3	7.41	5.96	0.45
Farmers	A1	7.12	5.26	0.44
	A2	7.78	4.57	0.37
	A3	7.38	4.98	0.40
	A4	7.68	4.66	0.38
	A5	6.97	5.43	0.44

CC from the restaurants' perspective are higher for SMFs (A1) than any of the other alternatives. In spite of empirical evidence from other studies, restaurants who work with SMFs rank them better than restaurants that work with intermediaries (A2).

Restaurant managers added consistency as an important variable in selecting their partners, which is often one of the main challenges for farmers, according to previously mentioned empirical studies. Nonetheless, for this case, restaurants who buy directly from SMFs rated their suppliers' consistency better than that of intermediaries.

Farmers mentioned that intermediaries can offer a more diverse group of products. While farmers only offer what they grow, intermediaries search for whatever the restaurants demand and this is an important asset for intermediaries; they are better at knowing the market and how to maintain long-term relationships with their clients. Working with intermediaries does reduce transaction costs of dealing with different SMFs for each type of product restaurants require.

Farmers had an overall lower classification of their partners; however, direct sales (A5) and sales to restaurants (A1) were the highest ranking options from their perspectives. Sales to intermediaries, whether small supermarkets (A2) or intermediaries (A4), had the lowest rankings according to farmers.

Although factories or packing companies (A3) had low rankings in some variables, their main virtue was that they often buy most of the farmers' harvests and offer the option of buying low-quality produce. These packing companies may buy produce that would be rejected as produce for fresh consumption.

In this regard and in restaurants' possibilities for fresh local procurement; one of the most valuable variables from the farmers' perspective is for them to sell all of their produce, and local restaurants cannot offer to buy it all since local supply is higher than local demand. Farmers reported having much difficulty in creating value-added products and therefore, they saw fresh production as the only possibility; none have developed value-added products. Time constraints in fresh production force them to sell as soon as possible, and according to individual responses, price is the determining factor.

When results were presented in the workshop, eight farmers mentioned that selling directly to the final consumer is a benefit (A5) but they also added there is not enough demand in local farmers' markets, so there is not an option for more farmers to engage in this time of selling mechanisms. Another fundamental problem is how intermediaries have captured this market—farmers' markets are not exclusively for SMFs.

Since farmers search for buyers who can buy all of their volume, organization of smallholders could enable them to search for new markets as a group and aim for better conditions; however, since there is no informal or formal organization, the association process would be a challenge.

The models were re-run categorizing farmers according to years of experience and level of education, (Table 34) since these variables were fundamental in determining whether win-win strategies or trade-offs could occur, according to the empirical research mentioned

Table 34. CC by alternative with segmented variables, La Fortuna, 2015

	Sub-groups	CC				
		A1	A2	A3	A4	A5
Experience	Experienced farmers >15 years (n = 82)	0.429	0.349	0.411	0.384	0.445
	Non experienced farmers <15 years (n = 26)	NA	0.354	0.335	0.350	0.445
Education level	Incomplete elementary (n= 24)	NA	0.365	0.316	0.413	0.445
	Complete elementary (n=58)	0.426	0.356	0.391	0.391	0.438
	High school incomplete (n=13)	0.322	0.393	0.354	0.362	0.438
	High school complete (n= 10)	0.322	0.393	0.354	0.362	0.438
	Higher education (n=3)	0.483	0.387	0.354	0.362	0.438

Neither farmers with low experience nor with low levels of education have had the opportunity to work with restaurants; which is an indicator that experience or education or a combination of both could provide higher possibilities of working with what farmers consider one of the best options in the local market.

Farmers with more experience had more positive responses toward their buyers; regarding education, farmers with complete elementary school or higher education had significantly higher rankings, and therefore perceptions, about selling directly to hotels.

In trying to propose intervention strategies for linking SMFs to high value chains, in this case to local restaurants, three such approaches have been observed in other empirical studies (World Bank 2008).

The first approach (case study of NorminVeggies a farmers' association in the Philippines) depends on a farmer leader and small farmer cluster in which a company links small groups of farmers to a commercial lead farmer who is in charge of providing his knowledge to increase overall performance of SMFs; the lead farmer gives constant training to enable the farmers to provide what the market demands (Concepcion et al. 2013).

The second approach, which has been widely discussed, is the marketing of agricultural products through cooperatives of small farmers (Kirsten and Sartorius 2002, Gulati *et al.* 2005, Bijman et al. 2012, Dries *et al.* 2004). Cooperatives are a way for small farmers to organize and provide them with larger volumes and larger bargaining capacity. The third approach is related to supermarket coordination of supply chains, in which they work from a focal-company viewpoint by coordination the rest of the supply chain, especially with small farmers (Reardon and Berdegué 2002, Götz *et al.* 2009).

Since there is low cooperation among SMFs, a cooperative association would be unlikely; however, restaurants could play a focal-company role. If they were to do this independently, however, they would probably impact only a few SMFs since local demand is much less than supply. Finally, farmer-leaders who could organize the supply chain and empower other farmers not only to grow higher quality product but also to merchandize them in a better way and create better market opportunities. Results from the questionnaires also identified the five farmers who most of the interviewed farmers most recognized as leaders or “good farmers” because they know how to grow different products better and because they have better knowledge of markets. Since there is local recognition, these farmers, with the support of MAG and CACORE, could lead sustainable strategies.

## **7.6 Conclusion and Recommendations**

This research addressed the reasons for low trading among SMFs and through fuzzy TOPSIS results in which both parties can weigh in variables and ranking of alternatives via linguistic criteria. Trading with SMFs remains a challenge but their ability to connect to global supply chains would certainly improve their standards of living and overall performance of

sustainable value chains. In this case, their ability to create local long-term partnerships would allow them to produce and retain local sustainable businesses.

Results show how trading among SMFs and restaurants would be a better option than most now available in the region. Experience and education can determine different perceptions of farmers in selection of supply chain partners. Further research on these topics would be needed to provide more confident estimators on preferences of partner selection.

Variables by which farmers' segmentation was done could include others suggested by the literature review, such as their involvement of farmers' organizations since organization of SMFs has proven to boost supply chain performance, however none of the respondents belong to any type of local farmers' organization and therefore the segmentation could not be done. The lack of any type of organization by SMFs diminishes their bargaining power and market access and, therefore, their possibilities to engage in nontraditional high value chains, such as the tourism industry through restaurants.

Policies that encourage farmer leaders could provide an alternative for linking SMFs to this high-value-added supply chain; farmers know each other since they are neighbors and there are already some leaders among them who have the respect of their colleagues and could eventually lead a local strategy.

Also, demands by conscientious tourists, as well as national or international programs oriented toward sustainable tourism and local sourcing, seem to offer one of the best options for improvement of trading systems with SMFs since initiatives from the agricultural sector are less likely to occur. While there are several tourism/community/development organizations in the region, there are none for the agricultural sector.

Concerning the selected variables of segmentation, experience was randomly selected at 15 years instead of using an accurate estimator. There is no information in the region to address what corresponds to enough years of experience to make a difference; further research should include a more representative estimator. Also, cultural aspects could play an important role, therefore results should not be assumed to be similar under different cultural circumstances; while in the agricultural sector of Costa Rica the associative culture is poor, it may be otherwise in other regions of the country. places.

## **8. Gap analysis through constrained AHP and fuzzy TOPSIS: case study for La Fortuna.**

### **8.1 Introduction**

A study conducted in 2012 revealed how restaurants and small and medium farmers (SMFs) located in La Fortuna, a northern district of Costa Rica, do not trade agricultural products; therefore, local sourcing for agricultural products is the least common of trading mechanisms (S. Canedo-Rivas 2012). Although there is local agricultural production, 63.3% of restaurants (19 out of 30 interviewed in a previous stage of this research) buy their agricultural products from intermediaries, who often travel long distances to supply fresh products.

La Fortuna is an important tourist attraction in Costa Rica,—tourism is fundamental to the country's economy. Sustainable tourism has proven to improve the well-being of regions or countries when local sourcing and community involvement occur. Although La Fortuna has some important sustainable characteristics, such as community participation, open communication, locally owned tourism enterprises and communitywide environmental practices (Matarrita-Cascante et al. 2010), local sourcing of agricultural products is missing for most restaurants (S. Canedo-Rivas 2012).

Agriculture is often one of the most vulnerable sectors; for farmers to have constant and local buyers would be an important asset for local development, especially in a region in which 17.4% of the population depends on agriculture, second highest after tourism-related activities and accounting for 26.5% of local GDP (INEC 2011). In the context of sustainable tourism, it is fundamental for sustainable regions to promote local sourcing, community involvement and overall local well-being; sustainable tourism principles include these criteria for sustainable destination certification by the Global Sustainable Tourism Council standards (GSTC 2016).

In order for SMFs and restaurants to analyze each of the possible trading alternatives in the region, 108 farmer interviews and 30 restaurant-manager interviews were carried out from September 2015 to February 2016. On one side, a fuzzy TOPSIS ranking of alternatives was applied to this information, creating the matrix of aggregated rankings of criteria and alternatives. A constrained AHP was conducted to estimate hierarchy weights of variables, but there was no consistency of individual responses. Therefore, a workshop was organized on June 7, 2016, in which the hierarchy was done through a visual organization of cards with the name and explanation of each variable.

An indicator of demands from both sides—SMF perspectives and restaurant representatives—was estimated, using a combination of analytic hierarchy process (AHP) and fuzzy TOPSIS. This indicator measures the gap or the distance between weighted rankings from both edges as an exploratory technique to address the distance between perceptions of

rankings and weights of two sides of an agri-food supply chain. Weights were estimated via a group decision-making procedure while rankings were estimated with standardized questionnaires.

Variables used for estimations were collected from previous empirical studies of fresh supply chains, the food industry and sustainable trading mechanisms (Kannan *et al.* 2009, Reardon, JA *et al.* 2005, Gulati *et al.* 2005, Torres and Momsen 2004, Van-der-Meer 2006, de Janvry and Sadoulet 2005, Norton *et al.* 2010, Zapata *et al.* 2011, Fleischer and Tchetchik 2005, Markelova *et al.* 2007). Since there is small trade among these actors, our hypothesis was they have strong differences among the criteria (variables) they consider important to establish a long-term trading mechanism.

Results from a previously conducted fuzzy TOPSIS indicated the best alternative for restaurants was to buy fresh produce from SMFs; it is the second best option from the farmers' perspective. The best option was for SMFs to sell directly through farmers' markets or street sales. Since our objective was to analyze the lack of trading between SMF and restaurants, the only alternative from the fuzzy TOPSIS considered for analysis was that of restaurants.

Results were expected to provide insights on the reasons behind the lack of trading between the abovementioned actors in a region whose sustainable values and principles are highly appreciated by tourists and the local community.

## **8.2 Methods**

AHP, is a multiple-criteria decision-making methodology developed by Saaty (1980); it is a tool for coping with unstructured complex problems using a hierarchical structure and pairwise comparisons between variables that are considered determinant for decision making. It is based on the construction of reciprocal pairwise comparison matrices of alternatives with respect to each criterion.

Decision-making procedures are often imprecise and respondents may not provide an exact intensity for each of the variable's importance or preference over other variables via a crisp number; these estimations are easier to provide through a linguistic scale, thus through fuzzy numbers. Applications of multi-criteria decision making regarding green supply chain management have mainly dealt with problems and success factors, performance measures and barriers (Boutkhom *et al.* 2016).

Recently, some authors have applied AHP as well as TOPSIS in environmental management applications in different fields, including the analysis and evaluation of suppliers (Büyüközkan and Çifçi 2012, Taylan *et al.* 2014, Lima-Junior *et al.* 2014).



Moreover, Saaty's AHP has had various approaches to weight fuzzification of AHP. Van-Laarhoven and Pedrycz (1983), Buckley (1985), Chang (1996) and Enea and Piazza (2004) have provided different estimation procedures for weight calculation; these approaches mainly differ from each other in the way of deriving fuzzy weights from a fuzzy pairwise comparison matrix. This research uses the constrained fuzzy arithmetic concept developed by Enea and Piazza (2004) and modified computational simplification by Krejčí *et al.* (2016).

Elements contained in the pairwise comparison matrices derive from triangular fuzzy numbers, obtained from each variable's membership function  $\mu_a$  derived from (Zadeh 1965):

$$\mu_a(x) = \begin{cases} 0, & x \leq a \\ \frac{x-a}{b-a}, & a < x \leq b \\ \frac{c-x}{c-b}, & b < x \leq c \\ 0, & x > c \end{cases} \quad (40)$$

To each number from the scale, an assigned linguistic term describing the intensity of importance or dominance of one object over the other was used. Saaty's original proposal for the estimation of this comparison mechanism is shown in Table 35.

Table 35. AHP fuzzy values and their interpretation for AHP

Linguistic scale	Value	Fuzzy Value	Interpretation
Equal		(1,1,1)	Same variable compared to itself
Equal importance	1	(1,1,3)	Requirements <i>i</i> and <i>j</i> are of equal importance: two alternatives contribute equally to the objective
Moderate importance of one over another	3	(1,3,5)	Moderate importance: experience and judgment slightly favor one activity ( <i>i</i> ) over the other ( <i>j</i> )
Essential or strong important	5	(3,5,7)	Strong importance: experience and judgment strongly favor one activity ( <i>i</i> ) over the other ( <i>j</i> )
Demonstrated importance	7	(5,7,9)	Very strong importance: experience and judgment very strongly favor one activity ( <i>i</i> ) over the other ( <i>j</i> ) (demonstrated dominance in practice)
Extremely preferred	9	(7,9,9)	Extreme importance: evidence supporting one activity over the other is of the highest possible order of affirmation
Reciprocals			If requirement <i>i</i> has a lower value than <i>j</i>

*Source. Adapted from Saaty (1980) and Kabir and Hasin (2011)*

AHP requires a comparison matrix, often called the D matrix, consisting of pairwise comparison of the elements with respect to each other, where  $n$  is the number of criteria evaluated ( $C_{ij}$ )

The pairwise comparison matrix  $D = \{a_{ij}\}_{i,j=1}^p$  is reciprocal:  $a_{ij} = 1/a_{ji}$  for all  $i, j \in \{1, \dots, p\}$ .

$$D = [\tilde{a}_{ij}] = \begin{pmatrix} \tilde{a}_{11} & \tilde{a}_{12} & \dots & \tilde{a}_{1n} \\ \tilde{a}_{21} & \tilde{a}_{22} & \dots & \tilde{a}_{2n} \\ & & \ddots & \\ \tilde{a}_{n1} & \tilde{a}_{n2} & \dots & \tilde{a}_{nn} \end{pmatrix} \quad (41)$$

A fuzzy number is used to represent comparisons among variables, *for example*.  $\tilde{I}$  is often defined as  $(1,1,c)$  and  $c$  can either be  $c = 2$  or  $c = 3$  (Ishizaka and Nguyen 2013). However, according to Enea and Piazza (2004),  $\tilde{I}$  as previously defined is not appropriate for expressing the linguistic term “equal importance.” If an expert assesses  $x_i$  to be equally important as  $x_j$ , then also  $x_j$  should be equally important as  $x_i$  and therefore,  $\tilde{a}_{ij}$  should be equal to  $\tilde{a}_{ji}$ .

According to Enea and Piazza (2004) if  $\tilde{a}_{ij} = (1,1,c)$ , then  $\tilde{a}_{ji} = 1/\tilde{a}_{ij} = (\frac{1}{c}, 1, 1) \neq \tilde{a}_{ij}$ . The linguistic term of equal importance is modeled by  $\tilde{I} = (\frac{1}{c}, 1, c)$ , where  $c > 1$ . Therefore; the estimation of the pairwise comparison matrix is done according to equations 4.5, 4.6 and 4.7.

To measure consistency of responses in the pairwise comparison matrix, Saaty (1980) defined the consistency ratio as

$$CI = \frac{\lambda - p}{RI(p - 1)} \quad (42)$$

From equation 4.3,  $\lambda$  is the maximal eigenvalue of  $D$ ,  $p$  is the dimension of  $D$  and  $RI$  is the random consistency index. As a rule of thumb, when  $CR < 0.1$ , the pairwise comparison matrix is considered consistent and when  $CR \geq 0.1$ , the pairwise comparison matrix is inconsistent.

Originally, Saaty (1980) proposed the estimation of weight through the normalized eigenvector correspondent to the largest eigenvalue of the pairwise comparison matrix (sum of weights =1). Another method, the geometric mean, is fuzzified and used instead because eigenvalues and fuzzy eigenvectors are hard to define in a rigorous way:

$$w_i = \frac{\sqrt[p]{\prod_{j=1}^p a_{ij}}}{\sum_{k=1}^p \sqrt[p]{\prod_{j=1}^p a_{kj}}}, i = 1, \dots, p \quad (43)$$

The equations used to estimate weights proposed by Enea and Piazza (2004) and Krejci (2016) were

$$w_{i1}^c = \min\left\{\frac{\sqrt[p]{\prod_{j=1}^p a_{ij}}}{\sum_{k=1}^p \sqrt[p]{\prod_{j=1}^p a_{kj}}}; a_{rs} \in [a_{rs1}, a_{rs3}], r, s = 1, \dots, p, r < s, a_{sr} = \frac{1}{a_{rs}}, r, s = 1, \dots, p, r < s, a_{rr} = 1, r = 1, \dots, p\right\}, \quad (44)$$

$$w_{i2}^c = \frac{\sqrt[p]{\prod_{j=1}^p a_{ij}}}{\sum_{k=1}^p \sqrt[p]{\prod_{j=1}^p a_{kj}}}, \quad (45)$$

$$w_{i3}^c = \max\left\{\frac{\sqrt[p]{\prod_{j=1}^p a_{ij}}}{\sum_{k=1}^p \sqrt[p]{\prod_{j=1}^p a_{kj}}}; a_{rs} \in [a_{rs1}, a_{rs3}], r, s = 1, \dots, p, r < s, a_{sr} = \frac{1}{a_{rs}}, r, s = 1, \dots, p, r < s, a_{rr} = 1, r = 1, \dots, p\right\} \quad (46)$$

The estimated weights (non-fuzzy numbers) were multiplied by a fuzzy aggregated matrix of alternatives to obtain an estimator than can measure weights as well as ranking of alternatives. Multiplication of fuzzy numbers by a scalar is estimated by:

$$(a_1, b_1, c_1) \odot (x_i) \simeq (a_1 * x_i, b_1 * x_i, c_1 * x_i) \quad (47)$$

Distances from farmers' responses and from restaurant responses were estimated as a proposal of a gap analysis to estimate the distance between the aggregated evaluation of variables from both perspectives by

$$d(\tilde{a}_1, \tilde{a}_2) = \sqrt{\frac{1}{3} [(a_1 - a_2)^2 + (b_1 - b_2)^2 + (c_1 - c_2)^2]} \quad (48)$$

### 8.3 Numerical implementation

In order to provide a hierarchical importance of variables considered in a decision-making procedure, especially to decide whether to trade with a specific actor, the following variables or criteria ( $C_i$ ) were considered:

1. quantity ( $C_1$ )
2. transportation system ( $C_2$ )
3. price ( $C_3$ )
4. quality ( $C_4$ ).
5. education of decision-makers ( $C_5$ )
6. distance from supply chain partners ( $C_6$ )
7. years in business: experience ( $C_7$ )
8. transparency of transactions: as proxy of risk aversion ( $C_8$ )
9. associative culture ( $C_9$ )
10. water and waste management ( $C_{10}$ )
11. organic production and access ( $C_{11}$ )
12. access to irrigation systems ( $C_{12}$ )

Weights were estimated through the analytical hierarchy process (AHP) via two pairwise comparison matrices: one for farmers' perceptions and the other from restaurant managers' perceptions. Both supply chain actors were asked to rank the importance of each of the abovementioned criteria with regard to each other via linguistic variables from Table 21.

Although field research included 108 farmers and 30 restaurant interviews, responses from farmers resulted in the pairwise comparison being inconsistent; therefore, this ranking was done in a workshop in which 16 people, including 14 farmers and two restaurant owners participated. The pairwise comparison of weights was estimated through the visual representation of distances on a scale in which each variable was represented with a card containing the name of the variable, as well as an explanation of what each variable meant.

Table 36. Membership function of linguistic scale for estimation of weights

Linguistic scale	Fuzzy number	Triangular fuzzy number
Equal importance	$\tilde{1}$	(1,1,3)
Moderate importance of one over another	$\tilde{3}$	(1,3,5)
Essential or strong important	$\tilde{5}$	(3,5,7)
Demonstrated importance	$\tilde{7}$	(5,7,9)
Extremely preferred	$\tilde{9}$	(7,9,9)
Reciprocals: $\tilde{3}^{-1}, \tilde{5}^{-1}, \tilde{7}^{-1}, \tilde{9}^{-1}$		

Results from the standardized questioners were, however, used in order to rank alternatives by individual responses, while weights were estimated according to a group decision-making procedure.

Ranking of alternatives that of different buyers' options was conducted by a linguistic perception of the farmers' supply chain partners, depending on who they sell their product to. The linguistic variables and their correspondent fuzzy numbers for evaluation of alternatives are in Table 37.

As mentioned before, pairwise comparison matrices of weights were used to estimate one non-fuzzy weight per each criterion, done using the Krejci *et al.* (2016) proposal of restricted fuzzy numbers.

Once weights were obtained, they were multiplied by each fuzzy number and a distance between the response from farmers and from restaurants was estimated. This distance was used to estimate the degree of agreement with their supply chain partners. It is estimated that if this distance is close to 0, then, there are no disagreements between buyers and sellers. Although this measurement does not compare results with the optimal solution, as in TOPSIS, it measures the degree of understanding among stakeholders; the closer it gets to zero, the fewer frictions there are among trading partners.

Table 37. Linguistic variables and their fuzzy values for alternative ranking

Likert-scale linguistic variable	$a_i$	$b_i$	$c_i$
Excellent	8	9	10
Very Good	6	7	8
Good	4	5	6
Fair	2	3	4
Poor	0	1	2

The estimation of the distance was also performed pairing high experience actors; farmers with 15 or more years of experience and restaurant owners or managers with more than 10 years of experience, as well as actors considered to have low experience.

#### 8.4 Results and discussion

Farmers and restaurant managers were asked to rank all the criteria and compare it to each other via numerical representations. The following pairwise comparison matrices (Table 38 and Table 39) were obtained for both the farmers and managers and were used to estimate weights of each criterion and their CC. From the following pairwise comparison matrices and equations 44, 45 and 46, weights observed in Tables 40, 41 and 42 were estimated.

Table 38. Pairwise comparison matrix for farmers

	C8	C3	C4	C1	C7	C12	C6	C10	C2	C11	C9	C5
C8	1	3	3	3	5	5	7	7	7	9	9	9
C3	3 <sup>-1</sup>	1	1	1	3	3	5	5	5	7	7	7
C4	3 <sup>-1</sup>	1	1	1	3	3	5	5	5	7	7	7
C1	3 <sup>-1</sup>	1	1	1	3	3	5	5	5	7	7	7
C7	5 <sup>-1</sup>	3 <sup>-1</sup>	3 <sup>-1</sup>	3 <sup>-1</sup>	1	1	3	3	3	5	5	5
C12	5 <sup>-1</sup>	3 <sup>-1</sup>	3 <sup>-1</sup>	3 <sup>-1</sup>	1	1	3	3	3	5	5	5
C6	7 <sup>-1</sup>	5 <sup>-1</sup>	5 <sup>-1</sup>	5 <sup>-1</sup>	3 <sup>-1</sup>	3 <sup>-1</sup>	1	1	1	3	3	3
C10	7 <sup>-1</sup>	5 <sup>-1</sup>	5 <sup>-1</sup>	5 <sup>-1</sup>	3 <sup>-1</sup>	3 <sup>-1</sup>	1	1	1	3	3	3
C2	7 <sup>-1</sup>	5 <sup>-1</sup>	5 <sup>-1</sup>	5 <sup>-1</sup>	3 <sup>-1</sup>	3 <sup>-1</sup>	1	1	1	3	3	3
C11	9 <sup>-1</sup>	7 <sup>-1</sup>	7 <sup>-1</sup>	7 <sup>-1</sup>	5 <sup>-1</sup>	5 <sup>-1</sup>	3 <sup>-1</sup>	3 <sup>-1</sup>	3 <sup>-1</sup>	1	1	1
C9	9 <sup>-1</sup>	7 <sup>-1</sup>	7 <sup>-1</sup>	7 <sup>-1</sup>	5 <sup>-1</sup>	5 <sup>-1</sup>	3 <sup>-1</sup>	3 <sup>-1</sup>	3 <sup>-1</sup>	1	1	1
C5	9 <sup>-1</sup>	7 <sup>-1</sup>	7 <sup>-1</sup>	7 <sup>-1</sup>	5 <sup>-1</sup>	5 <sup>-1</sup>	3 <sup>-1</sup>	3 <sup>-1</sup>	3 <sup>-1</sup>	1	1	1

Table 39. Pairwise comparison matrix for restaurants

	C8	C11	C7	C9	C4	C3	C6	C1	C10	C2	C12	C5
C8	1	1	1	1	3	3	3	3	5	5	5	5
C11	1	1	1	1	3	3	3	3	5	5	5	5
C7	1	1	1	1	3	3	3	3	5	5	5	5
C9	1	1	1	1	3	3	3	3	5	5	5	5
C4	3 <sup>-1</sup>	3 <sup>-1</sup>	3 <sup>-1</sup>	3 <sup>-1</sup>	1	1	1	1	3	3	3	3
C3	3 <sup>-1</sup>	3 <sup>-1</sup>	3 <sup>-1</sup>	3 <sup>-1</sup>	1	1	1	1	3	3	3	3
C6	3 <sup>-1</sup>	3 <sup>-1</sup>	3 <sup>-1</sup>	3 <sup>-1</sup>	1	1	1	1	3	3	3	3
C1	3 <sup>-1</sup>	3 <sup>-1</sup>	3 <sup>-1</sup>	3 <sup>-1</sup>	1	1	1	1	3	3	3	3
C10	5 <sup>-1</sup>	5 <sup>-1</sup>	5 <sup>-1</sup>	5 <sup>-1</sup>	3 <sup>-1</sup>	3 <sup>-1</sup>	3 <sup>-1</sup>	3 <sup>-1</sup>	1	1	1	1
C2	5 <sup>-1</sup>	5 <sup>-1</sup>	5 <sup>-1</sup>	5 <sup>-1</sup>	3 <sup>-1</sup>	3 <sup>-1</sup>	3 <sup>-1</sup>	3 <sup>-1</sup>	1	1	1	1
C12	5 <sup>-1</sup>	5 <sup>-1</sup>	5 <sup>-1</sup>	5 <sup>-1</sup>	3 <sup>-1</sup>	3 <sup>-1</sup>	3 <sup>-1</sup>	3 <sup>-1</sup>	1	1	1	1
C5	5 <sup>-1</sup>	5 <sup>-1</sup>	5 <sup>-1</sup>	5 <sup>-1</sup>	3 <sup>-1</sup>	3 <sup>-1</sup>	3 <sup>-1</sup>	3 <sup>-1</sup>	1	1	1	1

Since there was a visual representation from both parties when constructing the hierarchical importance of each criterion with respect to each other, CR were expected to be consistent ( $CR_{Farmers} = 0.0441$  and  $CR_{Restaurants} = 0.0441$ ).

While there are some similarities in criteria, such as transparency of transactions ( $C_8$ ), farmers however placed higher importance on price ( $C_3$ ), quantity ( $C_1$ ) and quality ( $C_4$ ), while restaurant managers chose experience of their supply chain partners ( $C_7$ ) and organic production and availability of agricultural products ( $C_{11}$ ).

Quantity, quality and prices relate directly to economic criteria since economic profit depends directly on them. Economic issues are the most important for farmers, since their overall well-being and that of their families depend directly on agriculture; 74.1% of interviewed farmer households depend 100% on agricultural income, although 62% mentioned they or their household members have also engaged in economic activities other than agriculture to support their families.

From these results, one can conclude why farmers are very price-oriented, since their main and, in most cases, only form of income comes directly from prices they obtain from their agricultural sales. Bargaining power of farmers in this region was also discussed; farmers reported they are often price takers; which is expected from small businesses with low production capacity.

Restaurants do not place a heavy weight on prices. For them, it is possible that expenses from agricultural products represent a low proportion relative to other expenses; however, this research provided no evidence on percentage agriculture products represented in total restaurant expenses. In this case, experience of farmers and environmental concerns, such as waste and water management and availability of organic products, were the most important criteria for supply chain partner selection.

Perceptions from restaurant owners or managers differ mainly because they have direct contact with customer demands. According to Seuring and Müller's literature review (2008) and conceptual framework for sustainable supply chain management, 96 out of 191 papers analyzed from 1994 to 2007 indicate how pressures and incentives for sustainability come directly from customer demands.

The distance between perceptions on weights provides a proposal for addressing the lack of trade between these actors; while farmers weight heavily on economic aspects, restaurants weight heavily on environmental concerns. Further research on willingness to pay local farmers for organic or sustainable practices could provide deep insight on policy measures that could trigger potential win-win collaborations among these partners.

Results from the overall ranking of alternatives provide a positive evaluation in most variables. Farmers seem unhappy with prices being paid ( $C_3$ ) and lack recognition on good water and waste management practices ( $C_{10}$ ) and irrigation systems ( $C_{12}$ ). These aspects were

perceived to be of low importance from the buyers' perspective, although they are fundamental from growers' perspectives. Also, offering organic production and access ( $C_{11}$ ) to buyers was important to buyer, but farmers were only willing to engage in organic production if prices were higher and markets risks lower, according to the general perspective of farmers expressed by one of them in the workshop.

Although restaurants claim to place a high weight on the availability of organic and sustainable products, farmers qualified their buyers poorly in this regard; therefore, they do not perceive the benefits of producing organic products.

Weighted rankings were estimated through equation 9 between the results obtained from farmers and from restaurants, in each case. The larger this gap, the least the actors were or would be willing to collaborate among farmers and restaurants. Results show how experienced actors from both sides of the supply chain have a better overall perception of their trading mechanisms with each other than inexperienced actors.

The larger gap estimated was in the general gap analysis (Table 40), in which all actors were included. Differences in perceptions of each other diminish when grouped in similar categories—in this case, experienced versus non-experienced actors (Table 41 and Table 42). The smallest gap obtained was that of experienced actors, which means experience of supply chain actors reduced frictions and provided common ground for joint collaboration and potential win-win strategies. Nonetheless, higher consumer demands on locally grown food may promote this kind of collaboration since buyers of agricultural products often have most of the bargaining power, especially when referring to small-scale farmers.

Table 40. General Gap Analysis

Criteria	Restaurants						Farmers						Estimated Distance (Gap)		
	Fuzzy TOPSIS			AHP	Weighted Rankings			Fuzzy TOPSIS			AHP	Weighted Rankings			
	a	b	c	w	aw	bw	cw	a	b	c	w	aw	bw	cw	
C1	(0.79,	0.89	1)	3%	(0.027	0.03	0.034)	(0.65	0.76	0.87)	15%	(0.095	0.111	0.127)	0.081
C2	(0.79	0.89	1)	2%	(0.027	0.03	0.034)	(0.75	0.88	1)	3%	(0.11	0.129	0.146)	0.098
C3	(0.76	0.88	1)	7%	(0.026	0.03	0.034)	(0.24	0.36	0.49)	15%	(0.035	0.053	0.072)	0.026
C4	(0.79	0.88	1)	7%	(0.027	0.03	0.034)	(0.8	0.9	1)	15%	(0.117	0.132	0.146)	0.102
C5	(0.75	0.88	1)	2%	(0.026	0.03	0.034)	(0.5	0.63	0.75)	2%	(0.073	0.092	0.11)	0.063
C6	(0.47	0.53	0.61)	3%	(0.016	0.018	0.021)	(0.56	0.63	0.74)	3%	(0.082	0.092	0.108)	0.076
C7	(0.78	0.89	1)	15%	(0.027	0.03	0.034)	(0.73	0.85	0.97)	7%	(0.107	0.124	0.142)	0.095
C8	(0.8	0.9	1)	27%	(0.027	0.031	0.034)	(0.8	0.9	1)	27%	(0.117	0.132	0.146)	0.101
C9	(0.79	0.89	1)	15%	(0.027	0.03	0.034)	(0.75	0.88	1)	2%	(0.11	0.129	0.146)	0.098
C10	(0.75	0.89	1)	3%	(0.026	0.03	0.034)	(0.36	0.49	0.65)	3%	(0.053	0.072	0.095)	0.045
C11	(0.77	0.88	1)	15%	(0.026	0.03	0.034)	(0.33	0.39	0.65)	2%	(0.048	0.057	0.095)	0.04
C12	(0.71	0.86	1)	2%	(0.024	0.029	0.034)	(0.36	0.55	0.73)	7%	(0.053	0.08	0.107)	0.054
Total															$\sum = 0.88$



Table 41. Gap Analysis for farmers and restaurants with low experience

Criteria	Restaurants							Farmers							Estimated Distance (Gap)
	Fuzzy TOPSIS			AHP	Weighted Rankings			Fuzzy TOPSIS			AHP	Weighted Rankings			
	a	b	c	w	aw	bw	cw	a	b	c	w	aw	bw	cw	
C1	(0.743	0.850	0.957)	3%	(0.025	0.029	0.033)	(0.800	0.900	1.000)	15%	(0.117	0.132	0.146)	0.103
C2	(0.759	0.866	0.973)	2%	(0.026	0.030	0.033)	(0.778	0.889	1.000)	3%	(0.027	0.030	0.034)	0.001
C3	(0.681	0.803	0.926)	7%	(0.023	0.027	0.032)	(0.100	0.200	0.300)	15%	(0.015	0.029	0.044)	0.009
C4	(0.743	0.850	0.957)	7%	(0.025	0.029	0.033)	(0.625	0.750	0.875)	15%	(0.091	0.110	0.128)	0.082
C5	(0.633	0.800	0.967)	2%	(0.022	0.027	0.033)	(0.778	0.889	1.000)	2%	(0.013	0.015	0.016)	0.013
C6	(0.463	0.540	0.650)	3%	(0.016	0.018	0.022)	(0.250	0.286	0.333)	3%	(0.009	0.010	0.011)	0.009
C7	(0.703	0.817	0.931)	15%	(0.024	0.028	0.032)	(0.778	0.889	1.000)	7%	(0.056	0.064	0.072)	0.036
C8	(0.755	0.855	0.955)	27%	(0.026	0.029	0.033)	(0.750	0.875	1.000)	27%	(0.200	0.233	0.266)	0.205
C9	(0.759	0.866	0.973)	15%	(0.026	0.030	0.033)	(0.778	0.889	1.000)	2%	(0.013	0.015	0.016)	0.015
C10	(0.563	0.688	0.813)	3%	(0.019	0.024	0.028)	(0.000	0.000	0.000)	3%	(0.000	0.000	0.000)	0.024
C11	(0.763	0.792	0.908)	15%	(0.026	0.027	0.031)	(0.000	0.267	0.533)	2%	(0.000	0.004	0.009)	0.024
C12	(0.000	0.043	0.086)	2%	(0.000	0.001	0.003)	(0.000	0.125	0.250)	7%	(0.000	0.009	0.018)	0.010
Total															$\sum = 0.53$

Table 42. Gap analysis for experienced farmers and restaurants

Criteria	Restaurants							Farmers							Estimated Distance (Gap)
	Fuzzy TOPSIS			AHP	Weighted Rankings			Fuzzy TOPSIS			AHP	Weighted Rankings			
	a	b	c	w	aw	bw	cw	a	b	c	w	aw	bw	cw	
C1	(0.8	0.9	1)	3%	(0.027	0.031	0.034)	(0.69	0.81	0.92)	15%	(0.101	0.118	0.135)	0.088
C2	(0.72	0.82	0.9)	2%	(0.012	0.013	0.015)	(0.75	0.88	1)	3%	(0.026	0.030	0.034)	0.017
C3	(0.72	0.82	0.9)	7%	(0.052	0.059	0.066)	(0.25	0.38	0.5)	15%	(0.037	0.055	0.073)	0.010
C4	(0.76	0.86	1)	7%	(0.055	0.062	0.069)	(0.8	0.9	1)	15%	(0.117	0.132	0.146)	0.070
C5	(0.8	0.9	1)	2%	(0.013	0.015	0.016)	(0.55	0.68	0.82)	2%	(0.009	0.011	0.013)	0.004
C6	(0.15	0.17	0.2)	3%	(0.005	0.006	0.007)	(0.59	0.68	0.79)	3%	(0.020	0.023	0.027)	0.018
C7	(0.7	0.8	0.9)	15%	(0.102	0.117	0.132)	(0.69	0.8	0.91)	7%	(0.049	0.057	0.066)	0.060
C8	(0.8	0.9	1)	27%	(0.213	0.239	0.266)	(0.8	0.9	1)	27%	(0.213	0.239	0.266)	0.000
C9	(0.185	0.22	0.3)	15%	(0.027	0.032	0.037)	(0.75	0.88	1)	2%	(0.012	0.014	0.016)	0.018
C10	(0.133	0.18	0.2)	3%	(0.005	0.006	0.008)	(0.32	0.47	0.63)	3%	(0.011	0.016	0.022)	0.010
C11	(0.171	0.24	0.3)	15%	(0.025	0.034	0.044)	(0.33	0.5	0.67)	2%	(0.005	0.008	0.011)	0.027
C12	(0.15	0.2	0.2)	2%	(0.002	0.003	0.004)	(0.48	0.73	0.97)	7%	(0.035	0.052	0.069)	0.051
Total															$\sum = 0372$

Figure 22 shows the gap between the perceptions of farmers and the perceptions of restaurant managers. Most of the explanation on the higher gap for low-experienced farmers comes from  $C_8$ , since weight for these criteria are the same for both actors. The gap is derived

from the alternative ranking done through fuzzy TOPSIS; small and medium farmers improve their perception of transparency of transactions of restaurants dependent on their experience.

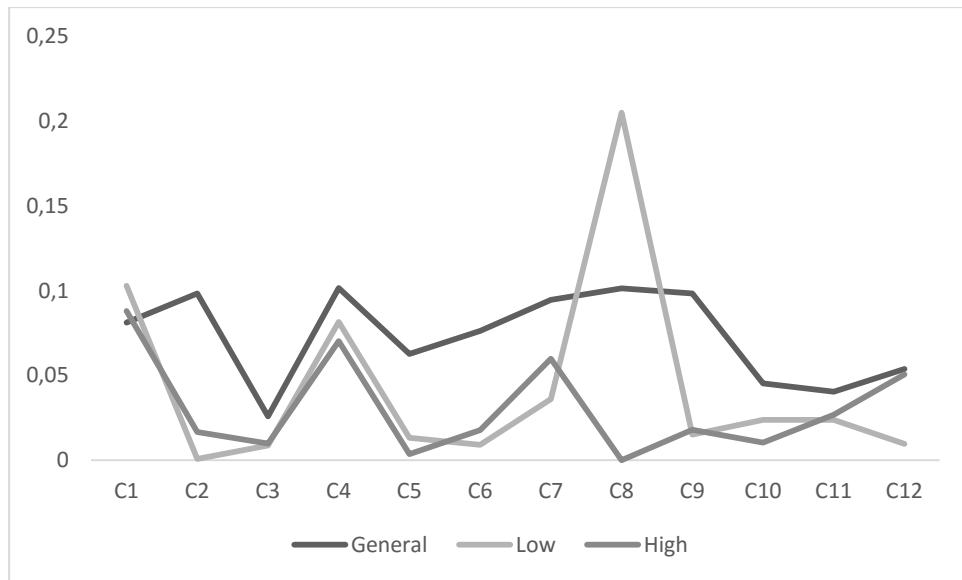

Figure 22. Representation of gaps between the perceptions of small and medium farmers and restaurants

## 8.5 Conclusions and recommendations

This research explores the use of AHP for weight estimation and fuzzy TOPSIS for alternative ranking in order to evaluate the distance between perceptions of small and medium farmers and restaurants managers when negotiating a transaction among them. The motivation underlying this study is to provide an evaluation of the lack of local agricultural sourcing for the food industry; especially with local restaurants; who often buy from intermediaries the same agricultural products farmers could provide.

Although intermediaries are needed along supply chains, these are often the ones who collaborate in a greater proportion to price formation. Since tourism and therefore the food industry related to this region is so strong, win-win situations could be achieved by collaboration; farmers could enter a new market and restaurants could buy agricultural products at lower costs, while cooperating with local development. The research analyzed the perception of both parties on selected criteria and on the evaluation of each other, proposing a gap analysis between them.

Weights of criteria were the same for transparency of transactions for both decision makers; however, results suggest that for actors to be interested in creating partnerships and

improving collaboration, restaurants should increase economic benefits for farmers and farmers should increase their environmental performance.

Since farmers are dependent on economic conditions provided by their buyers, and restaurants place high importance on environmental concerns, negotiations toward common ground seem to be aligned with higher prices for sustainable products, so that farmers can reduce their financial risk and restaurants can provide demands for current sustainable-tourism trends. International trends toward sustainable tourism and local sourcing can create an opportunity for this type of partnership to develop, since local sourcing and community development are part of the definition of sustainable tourism.

This gap analysis creates a tool for understanding how aligned supply chain partners are in terms of their governance mechanisms. The reasons behind the gap between actors are either because they are not aligned in the weights given to each variable or because of a low performance of the supply chain partner. It could also be a combination of these two aspects. This method facilitates understand of whether the gap between actors is a consequence of economic, environmental or social inconsistencies.

Policymakers could use this type of methodology as an input when considering what motivates both groups to trade. The implementation of new governance mechanism could consider where the larger gaps between weights and desired behavior of partners occurred. Assuming larger gaps mean less alignment, variables with larger gaps could be the first-addressed in the development agenda.

Although not consistent, weights are very different in individual responses and as a group of farmers. Further research on this topic would be interesting in order to compare weights depending on individual perception or group perception. Results may differ significantly if individual weights were used. Group decision making may turn responses toward general accepted values, which may not be the most honest responses, such as concerns for environmental conservation, organic production of agricultural goods and concerns about waste and water management.

When sourcing for high value-added food supply chains, incentives for linkage creation and vertical and horizontal integration become important as product requirements increase (Gulati *et al.* 2005). In the case of agriculture, unobservable characteristics provide an incentive for branding products, so that consumers can trust their sellers.

These coordination mechanisms create risk and information-sharing strategies in which co-dependency among actors pushes both sides (buyers and sellers) to coordinate and comply with established rules for gaining shared benefits. If smallholders do not participate in vertically integrated markets, they will have difficulties participating at all in high value markets, due to the high transaction costs in comparison with their competitors.

For these reasons, vertical coordination, contract farming or joint collaboration are proposed techniques for increasing trust and confidence among actors. According to Gulati *et al.* (2005), “Each of these forms of arrangement embodies different ways to share risks, costs and benefits of high value commodity supply chains.”

## 9. General overview and conclusions

La Fortuna has potential to receive certification as a sustainable destination; the main issue involves supply chain coordination, at least in the agriculture sector. Nonetheless, other sectors, such as hotel suppliers, should be analyzed in more detail. ADIFORT could play a leading role in the certification management since it is involved in many development projects in the region.

From the agricultural perspective, local sourcing represents only a small proportion of all fresh production in the region and thus it could not be the only option for farmers. However, to keep production targeted to the export market, as it is now, organization of small farmers could enhance the supply chain performance. As proposed in this research, a small group of farmers could act as farmer leaders and could potentially search and work for higher-paying markets.

### 9.1 La Fortuna's fresh product supply chain

A description of the supply chain of selected fresh products was done to provide a description of actors and their intertwined relationships. The main location was La Fortuna; however, some actors have regional, national and international connections, especially for food trade, and therefore the analysis included wider dimensions.

Most farmers (74%) obtain all of their income from agriculture and so are largely dependent on prices; if prices fluctuate heavily, their incomes become very unstable and risky. The wide selection of various crops of choice is a determinant factor in how farmers try to reduce risks (44.4% produce more than one product). Although it may seem evident that having a written contract would also reduce risks, 69.4% of farmers do not use any kind of contract and only 7.4% of farmers have a written one. Results suggest educational level and market knowledge are reduced for small and medium farmers.

Results indicate most farmers sell their products to intermediaries (49%) or factories (36%), and in most cases, they do not know the final destination of their product. Factories specialize in either frozen tubers and fruit or deep-fried tubers. Benefits from selling to factories rely specifically on transportation provided by companies and companies usually purchase the farmer's entire production, eliminating the farmer's need to search for other smaller buyers.

Production of cassava and taro are mostly targeted to the export market, while papaya, although also a potential export product, is often sold in the local market. In the case of plantains, most farmers consider it as a low risk product for the national market. However, there are processed plantain exports. Nonetheless, none of the farmers interviewed has actively engaged in exporting by their own means or created value-added products. These two aspects are essential components of supply chains to trigger development goals since they

would create economic sustainability for farmers and contribute to prosperity of local communities.

On the other side of the supply chain, restaurants buy mostly from intermediaries (63%) to reduce the cost of doing business with several small farmers in order to obtain wide variety of products—transaction costs. However, fuzzy TOPSIS results show those who have chosen to work exclusively with local small farmers ranked farmers above intermediaries in terms of closeness coefficients (CC). Nonetheless, according to estimations of this research, supply is higher year-round compared with the potential restaurant demand. Although La Fortuna's restaurants provide a good market option, it cannot be the only one, since production exceeds demand in all four products evaluated.

Information flows along the supply chain lack feedback since farmers only receive specifications regarding product quality standards and prices; farmers often mentioned their own low competitiveness in terms of market access and entrepreneurship to develop value-added products or access new (more profitable) markets. While farmers had information about product qualities and prices, they were quite limited in their ability to transform their products into value-added products and to access new (more profitable) markets

Although quality standards for selling to factories are known, farmers commented that these change depending on supply and demand. When supply is higher than demand, quality standards become stricter and therefore they receive lower prices for products considered as low quality, which would most likely be considered first quality when demand exceeds supply.

Therefore, governance structures are mostly determined by prices, and since farmers are price takers, buyers have all (or most) bargaining power; farmers can only adapt to conditions set by buyers. According to the definition of coordination mechanism proposed by Raikes *et al.*, (2000), the only type of coordination occurring in the region among these actors is an indicator of power asymmetries. In the farmers' decision-making process to select their partners, bounded rationality plays an important role: results suggest farmers find limitations to search for the best option.

Opportunism, as another determinant factor of transaction cost theory, states that supply chain actors would make decisions to maximize their own profits whether or not this is detrimental to their supply chain partners. Opportunism could also increase in this supply chain since, actors do not often engage in long-term contracts and so do not have an obligation to their "once in a lifetime" partners. Chances of taking advantage of their partners increase if they know they are not necessarily going to work together in the future.

Fresh products in general do not contain a high degree of asset specificity; however, in this region, fresh products used in the research are site specific and there are also human assets (know-how on agricultural production), but there are no product specifications that differentiate local products from those produced elsewhere. Product requirements from local buyers are also low, since the only aspect they consider or that may create asset specificity is

quality. From the perspective of buyers; their know-how is more highly valued than that of farmers since they know how national and international markets work.

The governance structure of the supply chain is mainly coordinated by buyers, with some institutional support in capacity building, education and financial areas. External agents that were most mentioned were either technical or higher-education institutions or governmental bodies (MAG), all of them in charge of providing training courses and in some cases agricultural inputs.

As for institutions and possible coordinators of the supply chain, MAG has an important influence in the region, specifically for papaya growers because of the organization of several training courses. This is an institution often mentioned by farmers and that has the credibility to organize farmers and provide guidance. But for restaurants and the tourism sector, MAG is not considered an authority, and since these two sectors are so disconnected. MAG only has influence in relation to farmers, not with restaurant managers or tourism in general.

Tourism has played a fundamental role in the region in terms of economic development and social mobility. Organization outside the agricultural sector has been good, especially for community development through ADIFORT; an institution widely involved in La Fortuna's development.

Farmers and restaurant interviewees mentioned that they sell or buy their product from intermediaries who transport it through CENADA, meaning that although they are at a close distance, agricultural products travel an additional 300 km (around 150 km from La Fortuna to CENADA) for products to be consumed in the exact region in which they were produced. Although food and resource losses caused by the inefficiencies of the supply chain were not estimated, a collaborative supply chain can certainly reduce both of these, contributing to the reduction of food loss as well as unnecessary resource use.

Further research on transportation and storage costs compared with prices paid to farmers and paid by consumers can provide further depth on fairness of prices along the supply chain. Since farmers do not transport or store their products, value added for most cases is short of what is considered high-value chains.

## **9.2 The perspective of farmers on fairness of agricultural prices**

The general negative perspective on prices has been noted. Farmers are often also net buyers of food and are well aware of the differences in prices received by them and the prices at which the same products are sold in local supermarkets. Differences in perceptions of price fairness depend on the type of buyer. Unsatisfied farmers are expected to search and keep on searching for different buyer options; which is part of the reason why there are no written contracts. If farmers do not consider their business relationship fair, they will not want to engage in a long-term partnership with those buyers.

There were significant differences between prices paid to farmers depending on the type of buyer. There are also significant differences between the perceptions of fairness of prices

dependant on the type of buyer, which provides another input for establishing how supply chain governance is determined.

### **9.3 Methods for supply chain coordination**

A literature review was conducted to search for empirical studies whose main goal was to determine enabling or restricting variables for farmers to collaborate in agri-food chains; 12 variables were selected for analysis and interviewees were also asked for additional variables they consider important.

Farmers did not mention any additional variable for analysis, however, restaurant managers added consistency. When asked about this variable, farmers agreed that restaurants are right about this topic and that it is a problem for farmers to be consistent since they deal with environmental problems and are always looking to sell their products at higher prices, even if this means they won't keep selling to the same buyers as before. However, La Fortuna's farmers were positively ranked by restaurants in terms of consistency.

Weights were estimated through constrained AHP by a group decision-making process; ranking of alternatives was done through individual interviews. For both, farmers and restaurants, the most important variable was transparency of transactions. Farmers were aware of the importance of sustainable practices since variables such as waste and water management and organic production were considered important in the APH; however, consumers were mostly in favour of sustainable destinations but were not willing to pay much more for differentiated food products than what they currently pay.

Farmers, from their perspectives, place higher importance on price, quantity and quality; all which are determinants of their income. A limitation often mentioned by small- and medium-scale farmers was their lack of contacts to facilitate providing what buyers demand. If there was any inconvenience in production, farmers often did not try to deliver according to the previously established conditions; while the intermediary was willing to fulfil buyers' requirements. Restaurants, however, placed higher importance on experience of their supply chain partners, organic production and availability of agricultural products.

The results were arrived at through a group decision-making process via a workshop and sharing of opinions among participants. Further research on the differences (if any) between group decision making and individual behaviour could provide differences on how farmers behave depending on their relationships and the factors influencing their decision-making process. Group pressures regarding commonly established values may have affected responses, which were slightly different than weights estimated through TOPSIS, although the hierarchy process methods were different.

With these variables, an indicator for the general contentment of both parties with their supply chain partners was estimated and can be understood as a proxy of trust among them. This indicator was estimated from the distances of perceptions of their partners in each variable multiplied by the importance of each of the variables.



The general indicator was estimated as a distance of 0.88. Actors were then divided as to low and high experience according to the number of years in business. The distance was reduced for both cases since there is higher correspondence between actors of the same category; however, interesting results were obtained. Low-experienced actors reported an indicator of 0.53 while high-experienced actors reported 0.372, meaning trust and overall contentment of business increased when experience was higher.

In order to include variables that change over time, experience rather than age was used since it is a fact that experience in some other field may not apply to farming conditions or market experience. Therefore, experience was exclusively considered as experience in the particular case of agriculture and tourist-related jobs, not necessarily in the same hotel or restaurant.

Average experience is high, which proves that when people engage in agricultural production, although conditions may not be the best (since perception of fairness is low), farmers tend to stay in the same business.

TOPSIS was proposed and conducted from perspectives, of farmers and different types of buyers. The goal was to provide an explanation of why small and medium farmers do not trade with restaurants even when they are located at a very close distance and restaurants often buy all of the selected products that are produced in the region.

Estimated CC confirmed that from restaurant perspectives and with the evaluated variables, farmers are the ones who provide a holistic "best" option for farmers, second to farmers' markets. On the other hand, farmers had lower overall closeness to ideal solution relative to buyers' evaluations; nonetheless, their preferences slanted toward selling directly to consumers in farmers' markets or street sales and to sell to restaurants.

TOPSIS results were partitioned according to level of experience and level of education to analyze whether these variables provide differences in perceptions of supply chain partners in this case of farmers (sellers). Neither low-experienced farmers nor farmers with incomplete elementary school have had the opportunity to work with restaurants directly, which provides some insight into how intervention strategies for sustainable supply chains can be linked to higher education and training courses for farmers.

Since the estimation of perceptions on results such as the evaluation of weight and rankings of alternatives (TOPSIS) also changed with experience, this variable is considered fundamental not only for decision making by farmers and restaurants but also for the perceptions of others (buyers). Farmers with more experience tend to rank their buyers better. Business knowledge makes them value what their buyers can offer, given why they have lived in the past.

Experience is a variable that is difficult to encourage through intervention strategies since it demands time—time for farmers to get to know better what they do (growing their products,

commercializing their products, developing contacts), but, entrepreneurship can be taught or developed through education.

Farmers need better conditions from the economic dimension while restaurants demand better options for environmental conditions. Better prices and buying conditions from the farmers' perspectives are key factors in searching for local buyers. Restaurants should focus more on providing better prices for their environmental requirements, since farmers, who seek higher prices for their produce, will demand even more for those with higher environmental standards. Initiatives by the private sector, such as CACORE's at the national level, provide an option for improved coordination.

Although this is not a particular problem in the region, because there is more supply than demand, small quantities produced were one of the main issues of SMFs. However, the lack of variety of products is a problem since restaurants have to search for many different SMFs who produce different products, increasing costs—mainly transaction costs.

A good option that has been widely used is to create local markets and organization for SMFs in order to trade at prices they consider fair. Since they would have more products and market access/knowledge, SMFs could be sharing in the pace of business instead of only following their buyers' decisions. This would be a long process, requiring training of farmers (especially managerial and tactical skills) and also requiring other options for SMFs since they produce more than the region can purchase.

CACORE has set an important milestone with its project; however, greater connection with other sectors is needed. Although MAG and other institutions are part of this initiative, local institutions as well as SMFs are not aware of the existence of the initiative and the benefits the community and the productive sector can obtain from it. Political institutions in the country have not promoted these initiatives sufficiently, which can be closely related to socioeconomic indicators, environmental issues, sustainability, climate-change and food loss. The lack of knowledge leads to lack of promotion.

As mentioned, strategies to link SMFs with high value-added sustainable supply chains is a challenge but, given this supply chain analysis, collaboration could be organized by farmer leaders, who could be reinforced by institutional acknowledgment and support from both MAG and CACORE as well as CANAECO—all of these as sector leaders.

If farmers continue to consider prices and the whole market as unfair to SMFs, there is a significant possibility that they could encourage their children to search for other economic activities, thereby continuing to reduce the agricultural sector as often occurs when countries move toward a better HDI. This would mean a shift in the structure of the country's economy since agriculture is the only section in which Costa Rica is a net exporter.

Sustainable supply chains can be modeled through fuzzy TOPSIS, and in order to consider a holistic approach, perspectives from both sides of the chain need to be taken into

account. Studies often include only one perspective, but since this project was intended for a holistic sustainable approach, two perspectives were considered.

Further research could also include how consumers, in this case tourists, selected their restaurants in order to identify which factors different types of tourists consider determinant for choosing a destination or local food provider. Dynamic changes in group decision making are still a gap for analysis in this context; the purpose of this research was not to identify differences in perceptions of individuals versus groups in decision making.

## 10. Recommendations

Results from this research open a door to insightful analysis of coordination (or lack of it) between supply chain partners. Conclusive research in this line of research should be emphasized so that coordination with small- and medium-scale farmers can be simplified. By understanding supply chain coordination mechanisms, it would be easier to negotiate with SMFs, especially in development agendas and for higher-value markets. Replication of similar research in other regions could raise the potential of analysis by analyzing similarities and differences.

Another important aspect that could be included in supply chain analysis and coordination mechanisms involve indicators of supply chain performance; these, however, can vary widely depending on the type of industry being analyzed. International standards are difficult to bring into a national context; however, these standards could be adapted to make them comparable. Globalization aims for international coordination and indexes for performance in agricultural supply chains could be a good comparative measurement, a tool for international benchmark and an indicator for loopholes.

If coordination mechanisms are rough, information regarding fair price estimation is one of the main aspects farmers mention often as a main problem since they consider prices unfair. Mechanisms to attach a fair price to different products are missing; however, the recommendation of this study is that these should not be fixed but rather aligned with country, product and market conditions. The proposed fair-price estimation provides a straightforward approach, but other detailed information regarding price transmission and international market effects could be included in further research on this topic.

Fuzzy sets and methods provide quantitative tools for modeling decision-making processes. The bottom-up methods used in this research provide the perspectives of those involved daily in business and therefore we did not address decision-making processes from a perspective of “what it should be” but rather “what it is” on a daily basis. This type of approach is fundamental for policy interventions so that the participants’ perspectives are considered, which are key for success.

For any type of supply chain coordination, the selection of products is fundamentally important. Products have to be well-known to both supply chain partners because of the vast differences there might be in the coordination, governance mechanisms and possible strategies of significantly different supply chains.

A key problem in several case studies is that policy changes fail to consider a holistic approach, tending to break the supply chain. There are numerous policy-related factors that if not considered in policy changes may decrease supply chain capabilities rather than increase performance goals. Changes in policy to promote supply chain coordination must consider two-sided perspectives (buyers and suppliers) since the coordination is expected to provide improved performance of the supply chain and not to set one group against the other.

### **Acknowledgements**

This research was possible thanks to the financial support of MICITT (Ministerio de Ciencia, Tecnología y Comunicaciones) and CONICIT (Consejo Nacional para Investigaciones Científicas y Tecnológicas) through a partial scholarship provided by the Fund of Incentives FI-0087-2013.

I am also grateful to the small- and medium-scale farmers, restaurant managers and stakeholders of La Fortuna for allowing me into their farms and their businesses.

## References

- Acuña, M.; Ruiz, K. 2010. Contribución del desarrollo turístico sobre el empleo rural no agrícola en Costa Rica. Centro Internacional de Política Económica para el Desarrollo, Universidad Nacional 14:85-107.
- Baykasoğlu A.; Gölcük, I. 2015. Development of a novel multiple-attribute decision making model via fuzzy cognitive maps and hierarchical fuzzy TOPSIS. *Information Sciences*: 75-98.
- Agrawal, A. 2011. Common property institutions and sustainable governance of resources. *World Development*: 1649-1672.
- Akwabi-Ameyaw, K. 1997. Producer cooperatives resettlement projects in Zimbabwe: lessons from a failed agricultural development strategy. *World Development*: 437-456.
- Andreatta, S. 1998. Transformation of the agro-food sector: lessons from the Caribbean. *Human Organization*: 414-429.
- Arias, O. 2005. Retos para la agricultura en Costa Rica. *Agronomía Costarricense*: 157-166.
- Ashley, C.; B. Jones. 2001. Joint ventures between communities and tourism investors: experience in Southern Africa. *International Journal of Tourism Research*: 407-423.
- Ashley, C; De Brien, P; Lehr, A; Wilde, H. 2007. *The role of the tourism tector in expanding economic opportunity* . Cambridge, Masachusetts: John F. Kennedy School of Government; Harvard University.
- Bacon, C. 2005. Confronting the coffee crisis: can fairtrade, organic and specialty coffees reduce small-scale farmer vulnerability in Northern Nicaragua. *World Development*: 497-511.
- World Bank. 2001. What is sustainable development. Retrieved from: <http://www.worldbank.org/depweb/english/sd.html>.
- Bélisle, F.J. 1984b. The significance and structure of hotel food supply in Jamaica. *Geography I*: 219-233.
- Bélisle, F.J. 1984a. Tourism and Food Imports: the case of Jamaica. *Economic Development and Cultural Change*: 819-842.
- Bélisle, F.J. 1983. Tourism and food production in the Caribbean. *Annals of Tourism Research*: 497-513.
- Berkes, F. 1998. *Dialogues of the commons: emerging directions for jointly used natural resources*. Vancouver: IASCP Presidential Address to Crossing Boundaries 7th Conference of the International Association for the Study of Common Property.

- Berno, T. 2006. *Bridging sustainable agriculture and sustainable tourism to enhance sustainability. Sustainable Development Policy and Administration*. Florida, USA: Taylor & Francis Group.
- Berstein, H. 1996. The political economy of the maize Filière. *The Journal of Peasant Studies*: 120-145.
- Bertrand, H. 1980. Le régime central d'accumulation d'après-guerre en France et sa crise. *Economie Rural*: 16-21.
- Bijman, J.; Iliopoulos, C.; Poppe, K.; Gijsenlinckx, C.; Hagedorn, K.; Hanisch, M.; Hendrikse, G.W.J.; Ollila, P.; Pykkönen, P.; Van-der-Sangen, G. 2012. *Support for farmers' cooperatives. Final Report*. European Commission.
- Bohdanowicz, P.; Curie-Kallhauge, A; Martinac, I. 2001. Energy-efficiency and conservation in hotels- towards sustainable tourism. *4th symposium on Asia Pacific Architecture, Hawaii*.: p.1-12.
- Bourgeois, R; Herrera, D. 1999. *Enfoque participativo para el desarrollo de la competitividad de los sistemas agroalimentarios*. San José, Costa Rica: IICA.
- Bowen, R.L; Cox, LJ; Fox, M. 1991. The interface between tourism and agriculture. *The Journal of Tourism Studies*: 43-54.
- Boyce, C; Neale, P. 2006. Conducting in-depth interviews. A guide for designing and conducting in-depth interviews for evaluation input. *Pathfinder International Tool Series*. Retrieved from: [http://www.cpc.unc.edu/measure/training/materials/data-quality-ortuguese/m\\_e\\_tool\\_series\\_indepth\\_interviews.pdf](http://www.cpc.unc.edu/measure/training/materials/data-quality-ortuguese/m_e_tool_series_indepth_interviews.pdf).
- Bozdağ, C.E; Kahraman, C; Ruan, D. 2003. Fuzzy group decision making for selection among computer integrated manufacturing systems. *Computers in Industry*: 13–29.
- Büyüközkan, G.; Çifçi, G. 2012. Novel hybrid MCDM approach based on fuzzy DEMATEL, fuzzy ANP and fuzzy TOPSIS to evaluate green suppliers. *Expert System Applications*: 39 (3) 3000-3011.
- Büyüközkan, G; Feyzioglu, O. 2004. A fuzzy-logic-based decision-making approach for new product development." *Int. J. Production Economics*: 27–45.
- CANAPEP (Cámara Nacional de Productores y Exportadores de Piña). *Statistics*. Retrieved from <http://canapep.com/estadisticas/>.
- Canedo-Rivas, S. *Condiciones e incentivos para la inclusión de pequeños productores locales como proveedores al suministro de productos agrícolas frescos de Tabacón, La Fortuna, Costa Rica*. CATIE, Turrialba. Costa Rica: MIAM. Master in International Agribusiness Management, 2012.
- Municipalidad de San Carlos. 2013. Patententes municipales.

- Carter, E. 1987. Tourism in the least developed countries. *Annals of Tourism Research*: 202-226.
- Chen-Chen, T.2000. Extension of the TOPSIS for group decision-making under fuzzy environment. *Fuzzy Sets and Systems*: 1-9.
- Chen, Y-J. 2011. Structured methodology for supplier selection and evaluation. *Information Sciences*: 1651-1670.
- Coase, R.1937. The nature of the firm. *Economica*: 386-405.
- Concepcion, S.D; Digal, L; Uy, JC. 2013. Keys to inclusion of small farmers in dynamic vegetable markets: the case of NorminVeggies in the Philippines. in *linking smallholder producers to modern agri-food chains. case studies from South Asia, Southeast Asia and China*, by Sharma, VP; Vorley, B; Huang, J; Suleri, AQ, Digal L;
- Reardon, JA (eds.). New Delhi; Mumbai, Kolkata, Chennai; Nagpur; Ahmedabad; Bangalore; Hyderabad, Lucknow: Allied Publishers Private Limited. p. 124-172.
- Crespo-Marquez, A. 2010. *Dynamic modelling for supply chain management*. Sevilla: Springer, 2010.
- CREST. 2012. *The case for responsible travel: Trends and Statistics*. Retrieved from: [http://www.responsibletravel.org/news/Fact\\_sheets/Crest\\_RTI\\_TrendStats\\_print\\_1\\_4%20\(3\).pdf](http://www.responsibletravel.org/news/Fact_sheets/Crest_RTI_TrendStats_print_1_4%20(3).pdf): Stanford University.
- CST (Certification for Sustainable Tourism). What is CST all about? Retrieved from: [http://www.turismo-sostenible.co.cr/index.php?option=com\\_content&view=article&id=2&Itemid=7&lang=en](http://www.turismo-sostenible.co.cr/index.php?option=com_content&view=article&id=2&Itemid=7&lang=en).
- Dammert, A.; Mohan, S. 2012. A survey of the economics of Fairtrade." *Journal of Economic Surveys*: 855-868.
- Debertin, D. 2012. *Agricultural Production Economics*. New Jersey, USA: Pearson Education.
- de Janvry, A; Fafchamps, M; Sadoulet, E. 1991. Peasant Household Behaviour with Missing Markets: Some Paradoxes Explained. *The Economic Journal*: 1400-1417.
- de Janvry, A.; Sadoulet, E. 1995. *Quantitative development policy analysis*. Baltimore and London: John Hopkins University Press.
- de Janvry, A; Sadoulet, E. 2005. Achieving success in rural development: toward implementation of an integral approach. *Agricultural Economics*: 75-89.
- Devo-Ganga, G.M; Luiz-Cesar R.C. 2011. A fuzzy logic approach to supply chain performance management.. *Int. Journal of Production Economics*: 177-187.



- Donovan, J; Stoian. D. 2012. *5 Capitals: A tool for assessing the poverty impacts of value chain development*. Turrialba, Cartago. : Technical Series. CATIE.
- Dorst, S; Van-Wijk, J; Vellema, S. 2010. Development value chains meet business supply chains. *the Partnership Resource Center*. Working Paper 002.
- Doxey, G.V. 1971. The tourism industry in Barbados: a socioeconomic assessment. *Kitchener, Canada: Dusco Graphics*.
- Dragunasu, R; Giovannucci, D; Nunn, N. 2013. The economics of Fairtrade. *Journal of Economic Perspectives*, 2013.
- Dries, L; Reardon, JA; Swinnen, J. 2004. The rapid rise of supermarkets in Central and Eastern Europe: implications for the agrifood sector and rural development. *Development Policy Review*: 22, 525-556.
- ECE/FAO (Economic Commission for Europe/ Food and Agriculture Organization). 1982. Report of the symposium on agriculture and tourism. *Report presented at FAO/ECE Working Party on Agrarian Structures and Farm Rationalization.*, 7-12 June 1982. New York. UN Economic Commission for Europe.
- Efendigil, T; Onut, S; Kongar, E. 2008. A holistic approach for selecting a third-party reverse logistics provider in the presence of vagueness. *Computers & Industrial Engineering*, 54 (2): 269–287.
- Elliot, J. 2013. *An Introduction to Sustainable Development*. New York: Routledge.
- Estado de la Nación. 2007. Diversidad de destinos y desafíos del turismo en Costa Rica: los casos de Tamarindo y La Fortuna. San José, Costa Rica.
- Euromonitor. 2015. Country Report: dairy in Costa Rica.
- EC (European Commission). 2015. Extracts of the specific programme for horizon 2020 societal challenge 2. *Establishing the specific programme implementing Horizon 2020 - the Framework Programme*. Retrieved from: [http://ec.europa.eu/agriculture/research-innovation/events/2014-06--brussels/h2020-specific-programme-extracts-sc2-agri\\_en.pdf](http://ec.europa.eu/agriculture/research-innovation/events/2014-06--brussels/h2020-specific-programme-extracts-sc2-agri_en.pdf).
- Fairtrade International. 2015. *Fairtrade Theory of change*. Version 2.0.
- FAO (Food and Agriculture Organization). 2016. *Food balances: livestock and fish primary*. Retrieved from: . <http://faostat3.fao.org/browse/FB/BL/E>.
- FAO (Food and Agricultural Organization).2003. *Unlocking the water potential of agriculture*. Rome: FAO.
- FAOSTAT. 2015. Exports of selected products. Retrieved from: <http://faostat3.fao.org/browse/T/TP/E>.

- Farrell, B; Twining-Ward, L. 2005. Seven steps towards sustainability: Tourism in the Context of New Knowledge. *Journal of Sustainable Tourism*: 109-122.
- Fernández-Alvarado, LF; Granados-Carvajal, E. 2000.. *Costa Rica: el Nuevo Marco Regulatorio del Sector Agrícola*. ECLAC; United Nations. Retrieved from: <http://www.cepal.org/publicaciones/xml/1/5751/LCL1453P.pdf>.
- Fleischer, A; Tchetchik, A. 2005.Does Rural Tourism benefit from agriculture? *Tourism Management*: 493–501.
- Font, X; Harris, C. 2004. Rethinking standards: from green to sustainable. *Annals of Tourism Research* 31 (4): 986–1007.
- Francesconi, G.N; Ruben, R. 2014. FairTrade's theory of change: an evaluation based on the cooperative life cycle framework and mixed methods. *Journal of Development Effectiveness*: 268-283.
- Friedmann, H. 1980. Household production and the national economy: concepts for the analysis of agrarian formations." *The Journal of Peasant Studies* 7 (2): 158-184.
- Ganga, GMD; Ribeiro-Carpinetti; LC. 2011. A fuzzy logic approach to supply chain performance management. *International Journal of Production Economics*: 177-187.
- Gascón, J. 2012. The limitations of community-based tourism as an instrument of development cooperation: the value of the social vocation of the territory concept. *Journal of Sustainable Tourism*: 716-731.
- Gereffi, G. 1994. The organisation of buyer-driven global commodity chains: how U.S. retailers shape overseas production networks. In *Commodity Chains and Global Capitalism*, by Gereffi, G; Korzeniewicz, M, p. 95-122. Westport, CT: Praeger.
- Gereffi, G. 2001. Las Cadenas productivas como marco analítico para la globalización. *Problemas del Desarrollo*. UNAM: 9-37.
- Gereffi, G; Karina Fernandez-Stark, K. 2001. *Global Value chain analysis: a primer*. North Carolina, USA: Center on Global Governance and Competitiveness. 2011.
- Gereffi, Gary; Korzeniewicz, M. 1994. *Commodity chains and global capitalism*. USA: Greenwood Publishing Group.
- Gereffi, G; Humphrey, J; Sturgeon, T. 2005. The Governance of global value chains. *Review of International Political Economy*: 78-104.
- Germann-Molz, J. 2004. Tasting an imagined Thailand: Authenticity and culinary tourism in Thai restaurants." In *Culinary Tourism*, by Long, L. Kentucky, USA: The Kentucky University Press. p.53-75.

- Gibbon, P. 2003. Value-chain governance, public regulation and entry barriers in the global fresh fruit and vegetable chain into the EU. *Development Policy Review* 21 (5-6): 615-625.
- Gibson, R. 2006. Sustainability assessment: basic components of a practical approach. *Impact Assessment and Project Appraisal*: 170-182.
- Giovanucci, D.; Scherr, S.; Nierenberg, D.; Hebebrand, C.; Shapiro, J.; Milder, J.; Wheeler, K. 2012. *Food and Agriculture: the future of sustainability strategic input to the Sustainable Development in the 21st Century (SD21)*. New York: United Nations Department of Economic and Social Affairs, Division for Sustainable Development. ,
- Goffe, P.W. 1975. How Developing Nations View Tourism: development potential on international tourism in Jamaica. *The Cornell Hotel and Restaurant Administration Quarterly*: 24-31.
- Gomes, A.J. 1993. Integrating tourism and agricultural development. *Tourism Marketing and Management in the Caribbean*.: New York, Routledge.
- Gooding, E.G.B. 1975. Food production in Barbados with particular reference to tourism."In *Doxey, G.V et al (eds). The tourist industry in Barbados*. Ontario: Dusco Graphics.
- Götz, L; Njavro, M; Hanf, JH; Pieniadz, A. 2009. Vertical coordination with growers in the supermarket fresh fruit and vegetables supply chain in Croatia. *Agarwirtschaft* 58(8): 363-370.
- Granovetter, M. 2005. The impact of social structure on economic outcomes. *Journal of Economic Perspectives* 33–50.
- Green, R; Dos Santos, R. 1992. Economía de red y reestructuración del sector agroalimentario. *Desarrollo Económico*: 199-225.
- GSTC (Global Sustainable Tourism Council). 2013. Global sustainable tourism criteria for destinations (GSTC-D). Retrieved from [http://www.gstccouncil.org/images/global%20sustainable%20tourism%20criteria%20for%20destinations%20gstc-d\\_v1%200\\_1nov13%20.pdf](http://www.gstccouncil.org/images/global%20sustainable%20tourism%20criteria%20for%20destinations%20gstc-d_v1%200_1nov13%20.pdf).
- GSTC (Global Sustainable Tourism Council). 2016. GSTC destinations program. Retrieved from: <https://www.gstccouncil.org/en/programs/gstc-destinations-program.html>.
- GSTC (Global Sustainable Tourism Council). 2014. Welcome to sustainable tourism. Retrieved from: <http://www.gstccouncil.org/>.
- Gulati, A; Minot, N; Delgado, C; Bora, S. 2005. Linking small-scale producers to markets: old and new challenges. *The World Bank*.
- Gulati, A; Minor, N; Delgado, C; Bora, S. 2005. Growth in high-value agriculture in Asia and the emergence of verbal links with farmers. *Paper workshop. Linking small-scale producers to markets: old and new challenges*. World Bank.

- Gunn, C. 1994. A perspective on the purpose and nature of tourism research methods. In *Travel, Tourism and Hospitality Research*, by J.R. Brent, JR; Goeldner, C. p: 3-11. New York: John Wiley and Sons, Inc.
- Guzmán, D.; Castaño, VM. 2006. La lógica difusa en ingeniería: principios, aplicaciones y futuro. *Ciencia y Tecnología* 87-107.
- Hart, S.L; Dowell; G. 2011. Invited editorial:a natural-resource-based view of the firm fifteen yaers after. *Journal of Management* (Invited editorial: a natural-resource-based view of the firm fifteen years after) 1464-1479.
- Hassall, J. 1999. Methods of analysing ordinal/interval questionnaire data using fuzzy mathematical principle . *Working Paper Series September*. University of Wolverhampton.
- Haynes, D. 2000. Transaction-costs economics and the evolving structure of agricultural production. *E-Commerce in Agribusiness*. Schmitz, T.G; C.B Moss,C.B; Schmitz, A; Kagan, A; Babcock., (eds). B.Florida, Florida Science Source, Inc.
- Hellin, J; Lundy, L; Meijer, M. 2009. Farmer organization, collective action and market access in Meso-America. *Food Policy* 16-22.
- Henson, S., and T. Reardon. Private agrifood standards: implications for food policy and the agri-food system." *Food Policy*, 2005: 241-253.
- Henson, S; Jaffee, S; Cranfield, J; Blandon, J; Siegel, P. World Bank.2008. *Linking african smallholders to high-value markets*. *Policy Research Working Papers*. Retrieved from: <http://elibrary.worldbank.org/doi/pdf/10.1596/1813-9450-4573>.
- Hertel, T. 2011. *The global supply and demand for agricultural. a perfect storm in the making?* Melbourne, Victoria.: Paper presented at the 55th Annual National Conference of the Australia Agricultural & Resources Economics Society.
- Hitt, M. 2012. Relevance of strategic management theory and research for supply chain management. *Texas A&M. Research Paper* (2): 9-13.
- Hwang, C.L; K. Yoon. 1981. *Multiple attribute decision making: methods and applications*. Berlin, Heidelberg, New York: Springer-Verlag.
- ICT (Instituto Costarricense de Turismo). 2016a *Acerca del ICT*. Retrieved from: <http://www.ict.go.cr/es/ict/quienes-somos.html#historia-y-marco-jurídico-institucional>.
- ICT (Instituto Costarricense de Turismo). 2016b. *Cámara de Turismo de la Zona Norte*. Retrieved from: <http://www.ict.go.cr/es/enlaces/camaras-y-asociaciones-de-turismo/article/33-camara-de-turismo-zona-norte-catuzon.html>.
- ICT (Instituto Costarricense de Turismo). *Impulso al crecimiento y desarrollo turístico en Costa Rica*. San José, Costa Rica: Estado de la Nación , 2015.

- IFC (International Finance Cooperation) 2013. *Working with smallholders: a handbook for firms building sustainable supply chains*. World Bank Group.
- INEC (Instituto Nacional de Estadística y Censos). 2014. *Censo Agropecuario* . Retrieved from: <http://www.inec.go.cr/agropecuario>.
- INEC (Instituto Nacional de Estadística y Censos). 2015. Encuesta Nacional de Hogares. Julio 2014. *Resultados Generales*. Retrieved from: [http://www.inec.go.cr/wwwisis/documentos/INEC/ENAH0/ENAH0\\_2015/ENAH0\\_2015.pdf](http://www.inec.go.cr/wwwisis/documentos/INEC/ENAH0/ENAH0_2015/ENAH0_2015.pdf).
- INEC (Instituto Nacional de Estadística y Censos). 2011. X Censo Nacional de Poblacion y VI de Vivienda. Retrieved from: <http://sistemas.inec.cr:81/bincri/RpWebEngine.exe/Portal?BASE=2011&lang=esp>.
- Momsen, J. 1972. Report on vegetable production and the tourist industry in St. Lucia. *University of Calgary, Canada*.
- Jervis, R. 1997. *System effects: complexity in political and social life*. Princeton NJ.: Princeton University Press.
- Kabir, G; Hasin, A. 2011. Evaluation of customer orientes sucess factors in mobile commerce using fuzzy AHP. *Journal od Industrial Engieneering and Managament*: 361-386.
- Kannan, D; Lopes de Sousa, AB; Chiappetta Jabbour, CB, 2014. Selecting green suppliers based on GSCM practices: using fuzzy TOPSIS applied to a Brazilian electronics company. *European Journal of Operational Research*: 432-447.
- Kannana, G; Pokhare, S; Kumarc, S. 2009. A hybrid approach using ISM and fuzzy TOPSIS for the selection of reverse logistics provider. *Resources, Conservation and Recycling*: 28–36.
- Kirsten, J.; Sartorius, K. 2002. Linking agribusiness ans small-scale farmers in develoing countries: is there a new role for contract farming? *Development Southern Africa* 19 (4) 503-529.
- Kosko, B. 1993. *Fuzzy thinking: The New Science of Fuzzy Logic*. New York : Hyperion.
- Kusi-Sarpong, S; Bai, C; Sarkis, J; Wang, X. 2015. Green supply chain practices evaluation in the mining industry using a joint rough sets and fuzzy TOPSIS methodology. *Resources Policy* 86-100.
- Kusumawardani, RP; Agintiara, M 2015. Application of Fuzzy AHP-TOPSIS Method for Decision Making in Human Resource Manager Selection Process. *Procedia Computer Science*: 638-646.
- Lane, B. 1994. Sustainable Rural tourism strategies: a tool for development and conservation. *Journal of Sustainable Tourism*: 12-18.

- Laumann, E; Marsden, P; Prensky, D. 1983. *The Boundary specification problem in network analysis, in applied network analysis: a methodological introduction.* by Burt, R; Minor, JB ( eds) . Beverly Hills: Sage Publications.
- Le, TA; Weaver, D; Lawton, L. 2012. Factors influencing the performance of community-based tourism in the semi-periphery of Vietnam: a resident perspective from Ta Van village. *AUTHE: The new golden age of tourism and hospitality; Book 2; Proceedings of the 22nd Annual Conference.* Melbourne, Vic:La Trobe University. p. 361-366.
- Lima-Junior, F.R; Osiro, L; Carpinetti, LCR. 2014. A comparison between fuzzy AHP and fuzzy TOPSIS methods to supplier selection. *Applied Soft Computing*: 21: 194-209.
- Liu, Z. 2003. Sustainable tourism development: a critique. *Journal of Sustainable Tourism*, 2003: 459-475.
- Long, L. 2004. *Culinary tourism.* The university press of Kentucky: Kentucky.
- Maertens, M; Swinnen, J. 2015. *Agricultural trade and development: a value chain perspective.* WTO Working Paper ERSD-2015-04.
- Torres-Maldonado, E. J. 1997. From tropical hell to tourist paradise: state intervention and tourist entrepreneurship in Mexican Caribbean." *PhD Dissertation.* The University of Texas at Austin.
- Markelova, H; Meinzen-Dick, R; Hellin, J; . Dohn, S. 2007. Collective action for smallholders market access. *Food Policy* 34(1): 1-7.
- Martin, R; Sunley, P.1998. Slow convergence? post-neoclassic convergence growth theory and regional development." *Economic Geography*: 201-227.
- Matarrita-Cascante, D; Brennan, M; Luloff, AE. 2010. Community agency and sustainable tourism development: the case of La Fortua, Costa Rica." *Journal of Sustainable Tourism*: 735-756.
- McElroy, J.L; Albuquerque, K. 1990. Sustainable small-scale agriculture in small caribbean islands. *Society and Natural Resouces* 109-129.
- MIDEPLAN (Ministerio de Planificaión). 2013. Costa Rica. Índice de Desarrollo Social. Rerieved from: <http://documentos.mideplan.go.cr/alfresco/d/d/workspace/SpacesStore/ab677d6c-fafd-4128-86df-a6aa04ab70ef/IDS%202013%20resumen.pdf>.
- Mikowski, M 2007. Tamarindo y La Fortuna. Estado de *La Nación*.
- Miller, L.G. 1985. Linking tourism and agriculture to create jobs and reduce migration in the Caribbean *Migration and Development in the Caribbean: the unexplored connection,* Pastor R.A (ed) London p. 289-300.

- Milne, S. 1992. Tourism and development in South Pacific Microstates. *Annals of Tourism Research*: 191-212.
- Moeinzadeh, P.; Hajfathaliha, A. 2009. A combined fuzzy decision making approach to supply chain risk assessment. *World Academy of Science, Engineering and Technology*: 12-23.
- Momsen, J. 1998. Caribbean tourism and agriculture: new linkages in the global era?" *Globalization and Neoliberalism: the Caribbean context*. , 1998: Lanham MD and Oxford: Rowman and Littleman Publishers. p.115-133.
- Momsen, J. 1986. Linkages between tourism and agriculture: problems for the smaller Caribbean economies. *University of Newcastle-upon-Tyre*. Seminar Paper 45.
- Momsen, J. 2002. NGOs, gender and indigenous grassroot development. *Journal of International Development*:1-9.
- Momsen, J. 1973. Report on vegetable production and the tourist industry in Motserrat. *University of Calgary, Canada*.
- Monk, J.; Alexander, C.S. 1986. Freeport fallout: gender, employment and migration on Margarita Island." *Annals of Tourism Research*: 393-413.
- UN (United Nations) 2000. Millenium Goals for development. Retrieved from: <http://www.un.org/en/mdg/summit2010/pdf/List%20of%20MDGs%20English.pdf>.
- Neto, F. 2002. A new approach on sustainable tourism development: moving beyond environmental protecction. ." *Natural Resiurces Forum*: 212-222.
- Nguyen, H.T; Pradas, NR; Walker, C.L; Walker, EA. 2000. *A first course in fuzzy logic and neural control* . Boca Raton, London, New York, Washington, D.C.: Champan & Hall/CRC.
- Norton, G, Alwang, J; Masters, W. 2010. *Economics of agricultural development. World Food Systemsn and Resource Use*. Madison Avenue, New York: Routledge, 2010
- Ferral, A.M. 1991. Tourism and agriculture on the north coast of the Dominican Republic. *Revista Geográfica*: 171-191.
- OECD (Organization for Economic Co-operation and Development). 2009. *Promoting pro-poor growth employment*. Retrieved from: <http://www.oecd.org/dac/povertyreduction/43514554.pdf>
- OECD/FAO. (Organization for Economic Co-operation and Development / Food and Agriculture Organization) 2016. Agricultural outlook 2016-2025. *OECD Publishing, Paris*. Retrieved from: [http://www.oecd-ilibrary.org/agriculture-and-food/oecd-fao-agricultural-outlook-2016\\_agr\\_outlook-2016-en](http://www.oecd-ilibrary.org/agriculture-and-food/oecd-fao-agricultural-outlook-2016_agr_outlook-2016-en).
- Olinto, P; Beegle, K; Sobrado, C; Uematsu, H. 2013.The state of the poor: where are the poor, where is extreme poverty harder to end, and what is the current profile of the World's

poor?. Retrieved from:  
<http://siteresources.worldbank.org/EXTPREMNET/Resources/EP125.pdf>.

Oliver, R.K; Webber, M.D. 1992. Supply-chain management: logistic catches up with strategy. *Reprint from Outlook 1982 in Logistics-The Strategic Issues*, ed Chistopher M: 63-75.

(UNWTO) World Tourism Organization. 2004. *Indicators of sustainable development for tourism destinations*. . Madrid, Spain.

(UNWTO) World Tourism Organization. The concept of sustainable tourism. Retrieved from:  
[www.world-tourism.org/sustainable/concepts.html](http://www.world-tourism.org/sustainable/concepts.html).

Pagell, M; Wu, Z. 2009. Building a more complete theory of sustainable supply chain management: using case studies from 10 exemplars. *Journal of Supply Chain Management: 37-56*.

Patil, S; Ravi Kant. 2014. A fuzzy AHP-TOPSIS framework for ranking the solutions of knowledge management adoption in supply chain to overcome its barriers. *Expert Systems with Applications (41): 679-693*.

Pattullo, P. 1996. Last resorts. *London. Latin America Bureau and Cassell*.

Guimarães-Pereira, A; Pedrosa, T; Simon, KH; Matovelle, A. 2013. In-depth interviews. *Institute for Environmental Studies. University of Amsterdam*. Retrieved from:  
[http://www.ivm.vu.nl/en/Images/PT8\\_tcm234-161513.pdf](http://www.ivm.vu.nl/en/Images/PT8_tcm234-161513.pdf)

Pike, A; Rodriguez-Pose, A; Tomaney, J. 2006. *Local and regional development*. New York: Routledge,

PIMA (Programa Integral de Mercadeo Agropecuario). 2013. *Tendencias de consumo de: frutas, hortalizas, pescado y mariscos en las familias de Costa Rica*. San José, Costa Rica.

Pingali, P., Y. Khwaja, and M. Meijer. 2005. Commercializing small farms: reducing transaction costs. *The Future of Small Farms*, 2005: 61-78.

IFPRI (International Food Policy Research Institute). The unfinished agenda perspectives on overcoming hunger,poverty, and environmental degradation. by Pinstrup-Andersen, Per; Pandya-Lorch, R (eds). Retrieved from:  
<http://www.ifpri.org/sites/default/files/publications/ufa.pdf>.

Pizam, A; Sussmann, S. 1995. Does nationality affect tourist behavior? *Annals of Tourism Research 22(4): 901-917*.

UNEP/UCR (United Nations Development Programme/Universidad de Costa Rica). 2011. Atlas de desarrollo humano cantonal de Costa Rica. Retrieved from:  
<http://www.pnud.or.cr/mapa-cantonal/>.



- Podolny, JM; Page, K.L.1998. Network forms of organization. *Annual Review of Sociology*, 1998: 57-76.
- Porter, M. 2008. *Regional Competitiveness in a global economy*. Washington, D.C.: The Summit for American Prosperity The Brookings Institution, 2008.
- Porter, M. 1985. *Ventaja competitiva. creación y sostenimiento de un desempeño superior*. México, D.F.: Compañía Editorial Continental, S.A. de C.V.
- Prakash, C; Barua, M.K. 2015. Integration of AHP-TOPSIS method for prioritizing the solutions of reverse logistics adoption to overcome its barriers under fuzzy environment. *Journal of Manufacturing Systems* 37(3): 599-615.
- Proleche (Cámara Nacional de Productores de Leche). 2013 Situación actual y perspectivas del sector lácteo costarricense. Visión de la cámara nacional de productores de leche. San Carlos, Costa Rica. Retrieved from: [http://www.proleche.com/recursos/documentos/congreso2013/Situacion\\_actual\\_y\\_perspectivas\\_del\\_sector\\_lacteo\\_a\\_nivel\\_nacional\\_Vision\\_de\\_la\\_Camara\\_Lic\\_Jorge\\_Manuel\\_Gonzalez\\_Echeverria\\_Costa\\_Rica.pdf](http://www.proleche.com/recursos/documentos/congreso2013/Situacion_actual_y_perspectivas_del_sector_lacteo_a_nivel_nacional_Vision_de_la_Camara_Lic_Jorge_Manuel_Gonzalez_Echeverria_Costa_Rica.pdf), 2013.
- Quirós, M. 2013. Costa Rica y Nicaragua son los reyes de la producción láctea. *MyT*.
- Ragin, C. 2000. *Fuzzy-set social science*. Chicago and London: The University of Chicago Press.
- Raikes, P; Friis-Jensen; Ponte, S. 2000. Global commodity chain analysis and the french *Filière* approach: Comparison and Critique." *Economy and Society* 29 (3): 390-417.
- Ramos, J. 1998. Una estrategia de desarrollo a partir de complejos productivos entorno a los recursos naturales. *CEPAL*. p.105- 125.
- Reardon, T; Berdegú, J.A. 2002. The rapid growth of supermarkets in Latin America. *Desarrollo y Política* 20 (4): 371-388.
- Reardon, T; Berdegú, J.A; Timmer, C.P; Cabot, T; Mainville, D; Flores, L; Hernandez, R; Neven, D; Balsevich, F. et al. 2005. Links among supermarkets, wholesalers, and small farmers in developing countries: conceptualization and emerging evidence. *The Future of Small Farmers*. Proceedings of a Research Workshop. p. 45-76.
- Redford, K.H; Dilis, R; Sunderland, T.C.H. 2013. Linking Conservation and Poverty Alleviation: A Discussion paper on good and best practice in the case of the Great Ape. *PCLG Discussion Paper No 11*. Retrieved from: <http://pubs.iied.org/pdfs/G03714.pdf>
- Regmi, A. 2001. *Changing structure of global food consumption and trade*. Washington DC: Market and Trade Economics Division, Economic Research Service, Agriculture and Trade Report. WRS.
- Rivera, J; Leon, P. 2005. Chief executive officers and voluntary environmental performance: Costa Rica's Certification for Sustainable Tourism. *Policy Sciences*: 107-127.

- Ruiz-Ballesteros, E. 2011. Social-ecological resilience and community-based tourism: an approach from Agua Blanca, Ecuador. *Tourism Management*: 656-666.
- Saaty, T. 1977. A Scaling method for priorities in hierarchical structures. *Journal of Mathematical Psychology* 15(3): 234-281.
- Saaty, T. 1990. How to make a decision: the analytic hierarchy process. *European Journal of Operational Research*, 1990: 9-26.
- Saaty, T. 1990. *Multicriteria decision making: the analytic hierarchichal process*. New York: Mc Graw Hill, 1980.
- Sami, M; Shiekhdavoodi, M.J; Pazhohanniya, M; Pazhohanniya, F . 2014. Environmental comprehensive assessment of agricultural systems at the farm level using fuzzy logic: a case study in cane farms in Iran. *Environmental Modelling & Software* 58: 1-14.
- Saville, N.M. 2001. Practical strategies for pro-poor tourism: a case study of pro-poor tourism and SNV in Humil District, West Nepal. *Working Paper N. 8 for Center for Responsible Tourism at the University on Greenwich. IIED, IAD*.
- Schiefer, G. 2002. Environmental control for process improvement and process efficiency in supply chain management –the case of the meat chain. *International Journal of Production Economics* 78: 197–206.
- SEPSA/Procomer (Secretaria Ejecutiva de Planificación Sectorial Agropecuario/ Promotora de Comercio Exterior de Costa Rica). 2008. Región Huetar Norte. Oferta exportadora actual y oferta potencial de productos agropecuarios alternativos. Retrieved from: [http://www.infoagro.go.cr/MarcoInstitucional/Documents/Huetar\\_NorteLibro-final.pdf](http://www.infoagro.go.cr/MarcoInstitucional/Documents/Huetar_NorteLibro-final.pdf).
- Seuring, S; Müller, M. 2008. From literature review to a conceptual framework for sustainable supply chain management. *Journal of cleaner production*:(16) 1699-1710.
- Seuring, S. 2013. A review of modeling approaches for sustainable supply chain management. *Decision Support Systems*: 1513–1520.
- Sharkey, D.A; Momsen, J. 1995. Tourism in Dominica, West Indies: problems ans prospects. *Caribbean Geography*: 40-51.
- Sharpley, R. 2000. Tourism and Sustainable developmnet: exploring the theorethical Divide. *Journal os Sustainable Tourism*: 1-19.
- Shaw, G, Williams, A.M. 1994. Critical issues in tourism: a geographical perspective. *Oxford and Cambridge MA: Blackwell*.
- Shepard, R. 2005. *Quantifying Environmental Impact Assessments Using Fuzzy Logic*. Troutdale. Oregon: Springer.

- Silva, A. 2009. Revisión Crítica del enfoque de filiereo cadena productiva agroalimentaria. *Asociación Argentina de Economía Agraria. Reseach Gate*. Retrieved from: [https://www.researchgate.net/publication/259105321\\_Revisin\\_Crtica\\_del\\_Enfoque\\_de\\_Filire\\_o\\_Cadena\\_Productiva\\_Agroalimentaria](https://www.researchgate.net/publication/259105321_Revisin_Crtica_del_Enfoque_de_Filire_o_Cadena_Productiva_Agroalimentaria).
- Silva, R. 2006. Acerca de la coordinación y la integración verticales. *Americarne*: 22-24.
- Simon, H. 1958. Models of Man. *Journal of the American Statistical Association* 53(282): 600-603.
- Sims, R. 2009. Food, place and authenticity: local food and the sustainable tourism experience. *Journal of Sustainable Tourism* 17 (3): 321-366.
- Law N° 37911-MAG. 2013. Sistema de registro del ministerio de agricultura y ganadería, para certificar la condición de pequeño y mediano productor agropecuario (PYMPA). Retrieved from: <http://www.mag.go.cr/legislacion/2013/de-37911.pdf>.
- Sneddon, C; Howarth, R.B; Norgaard, RB. 2005. Sustainable development in a post-Brundtland world. *Ecological Economics*: 253– 268.
- Sodhi, B; Prabhakar, T.V. 2015. A Simplified description of fuzzy TOPSIS. Retrieved from: *eprint arXiv:1205.5098*, 2012: 3.
- Springer, N, Garbach, K; Guillozet, K; Haden, V.R; Hedao, P; Hollander, A.D; Huber, P.R; Ingersoll, C; Langner, M; Lipari, G; Mohammadi, Y; Musker, R; Piatto, M; Riggle, C; Schweisguth, M; Sin, E; Snider, S; Vidic, N; White, A; Brodt,S; Quinn, J.F; Tomich, T:P. 2015. Sustainable sourcing of global agricultural raw materials: assessing gaps in key impact and vulnerability issues and indicators. *PLoS ONE* 10(6): e0128752. doi:10.1371/journal.pone.0128752.
- Stoian, D; Gotret, M.V. 2011. Ejes temáticos para el fortalecimiento de cadenas (CATIE). *Cadenas Productivas y Desarrollo Económico Rural en Latinoamérica*: 125-149.
- Student Learning Center. Lincoln University. 2006. Retrieved from: <http://library.lincoln.ac.nz/Global/Library/Learning/Maths%20and%20Stats/QMET%20103/Sample-size.pdf>.
- Sutherland, N.S. Agriculture and tourism in the Scottish Highlands and Islands. *Report Transmitted by the Government of the United Kingdom*.
- Tacoli, C. 2004. Rural-urban linkages and pro-poor agricultural growth: an overview. Retrieved from: <http://www.oecd.org/development/povertyreduction/36562896.pdf>.
- Taylan, O, Bafail, A.O Abdulaal, R.M.S; Kabli M.R. 2014. Construction projects selection and risk assessment by fuzzy AHP and fuzzy TOPSIS methodologies. *Applied Soft Computing* 17: 105-116.
- Telfer, D; Wall, G. 1996. Links between tourism and food production. *Annals of Tourism Research* 23(2): 635-653.

- Telfer, D.J. 1996. Food Purchase in a five-star hotel: a case study of the Aquila Prambanan Hotel, Yogyakarta, Indonesia. *Tourism Economics: The Business and Finance of the Tourism and Recreation*: 321-338.
- Teubal, M. 1999. Complejos y sistemas agroalimentarios: aspectos teórico-metodológicos. *Estudios Rurales, Teorias Problemas y Estrategias Metodológicas*: 97-119.
- Teuteberg, F; Wittstruck, D. 2010. A systematic review of sustainable supply chain management research: what is there and what is missing. *Accounting and Information Systems, University of Osnabrück*: 1001-1015.
- TICA. *Ministerio de Hacienda. Costa Rica*. 2015. Retrieved from: <https://www.hacienda.go.cr/tica/web/hcnduncml.aspx>
- Torres, R. 2000. Linkages between tourism and agriculture in Quintana Roo, Mexico. *Ph. D. Dissertation*,. University of California at Davis.
- Torres, R; Momsen. J.H. 2004. Challenges and potential for linking tourism and agriculture to achieve pro-poor tourism objectives. *Progress in Development Studies*: 294–318.
- Truong, V.D; Hall, C.M; Garry, T. 2014. Tourism and poverty alleviation: perceptions and experiences of poor people in Sapa, Vietnam. *Journal of Sustainable Tourism*: 1-19.
- Turner, L; Ash, J. 1975. The Golden Hordes: International tourism and the pleasure of periphery. *London*.
- Tyagi, M; Kumar, P; Kumar, D. 2014. A hybrid approach using AHP-TOPSIS for Analyzing e-SCM Performance. *Procedia Engineering*: 2195-2203.
- Tyrakowski, K. 1986. The Role of tourism in land utilization conflicts on the Spanish mediterranean coast. *GeoJournal*: 19-26.
- UN (United Nations). 2007. Indicators of sustainable development guidelines and methodologies. Retrieved from: <http://www.un.org/esa/sustdev/natlinfo/indicators/guidelines.pdf>.
- UNEP (United Nations Environmental Programme). 2005. *Making tourism more sustainable. a guide for policy makers*. Paris & Madrid: UNEP.
- UNEP (United Nations Environmental Programme). 2013. Negative economic impacts of tourism. Retrieved from: <http://www.unep.org/resourceefficiency/Business/SectoralActivities/Tourism/FactsandFiguresaboutTourism/ImpactsofTourism/EconomicImpactsofTourism/NegativeEconomicImpactsofTourism/tabid/78784/Default.aspx>.
- UNEP (United Nations Environmental Programme). 2011. Towards a green economy. Pathways to sustainable development and poverty eradication. Retrieved from: [http://www.unep.org/greeneconomy/Portals/88/documents/ger/ger\\_final\\_dec\\_2011/Green%20EconomyReport\\_Final\\_Dec2011.pdf](http://www.unep.org/greeneconomy/Portals/88/documents/ger/ger_final_dec_2011/Green%20EconomyReport_Final_Dec2011.pdf).

- UNEP (United Nations Environmental Programme). 2015. *Decisions by topic: rural development*. Retrieved from: <https://sustainabledevelopment.un.org/topics/ruraldevelopment/decisions>.
- UN/UNWTO (United Nations Environmental Programme/ World Tourism Organization). 2005. *Making tourism more sustainable: a guide for policy makers*.
- UN (United Nations). 2012. Global sustainable tourism council. Retrieved from: <http://www.unfoundation.org/what-we-do/campaigns-and-initiatives/global-sustainable-tourism-council/>.
- USAID (U.S Agencyfor Development). 1984. The study of linkages between tourism and local agriculture in Grenada, St. Vincent, St. Lucia and the Bahamas. *Study Report*.
- Van der Meer, C. 2006. Exclusion of small-scale farmers from coordinated supply chains. In *Agro-food chains and Networks for Development*. Ruben, R; Slingerland, M; Nijhoff, H (eds). Netherlands: Springerp. 209-217
- van der Straaten, J. 2002. Can sustainable tourism positively influence rural regions? In *Tourism and Sustainable Development*. Hall, D; Richards, G (eds). London: Routledge. p221-231
- Vasileiou, K.; Morris J. 2006. The sustainability of the supply chain for fresh potatoes in Britain. *Supply Chain Management: An International Journal* 11 (4), 317–327.
- Vorley, B. 2001. *The chains of agriculture: sustainability and the restructuring of agri-food markets*. Opinion. World Summit on Sustainable Development. International Institute for Environment and Development .
- Waas, T; Verbruggen, A; Wright, T- 2011. Sustainable development: a bird’s eye view. *Sustainability* (3) 1637-1666.
- WCED (World Commission on Environment and Development). 1987. Our common future. Retrieved from: [http://conspect.nl/pdf/Our\\_Common\\_Future-Brundtland\\_Report\\_1987.pdf](http://conspect.nl/pdf/Our_Common_Future-Brundtland_Report_1987.pdf).
- Weaver, D.B. 1991. Alternative to mass tourism in Dominica. *Annals of Tourism Research*: 414-432.
- Wehrli, R; Egli, H; Lutzenbeger, M; Pfister; D; Schwarz, J; Stetler, J. 2011. Is there demand for sustainable tourism? study for the world tourism forum lucern.. *ITW Working Papers Series Tourism*. University of Applied Sciences and Arts.
- Williamson, O. 1979. Transaction-Cost Economics: The Governance of Contractual Relations . *Journal of Law and Economics* 22 (2), 233-261.
- Wilkinson, Kenneth. *The community in rural America*. Middleton, WI: Social Ecology Press, 1991.

- Williamson, O. 1991. Comparative Economic Organization: The Analysis of Discrete Structural Alternatives." *Administrative Science Quarterly* 36 (2), 269-296.
- Williamson, O. 1985. *The Economic Institutions of Capitalism*. Macmillan. Inc. New York-London.
- Winters, P; Corral, L; Moreda-Mora, Adela. 2013. Assessing the Role of Tourism in Poverty Alleviation: a Research Agenda." *Development Policy Review*: 177-202.
- World Bank. 2008. *World Development Report. Agriculture for Development*. Washington DC: The International Bank for Reconstruction and Development / The World Bank.
- World Economic Forum. 2016. *Global Competitiveness Index*. Retrieved from: <http://reports.weforum.org/global-competitiveness-report-2015-2016/economies/#economy=USA>.
- Zadeh., L. 1965. Fuzzy sets. *Information and Control* 8:338–353.
- Zapata, M.J; Hallb, M; Lindoc, P; Vanderschaeghe, M. 2011. Can community-based tourism contribute to development and poverty alleviation? lessons from Nicaragua. *Current Issues in Tourism* 725-749.
- Zare, K; Javad Mehri.Tekmeh, and Sepideh Karimi. A SWOT framework for analyzing the electricity supply chain using an integrated AHP methodology combines with fuzzy-TOPSIS. *International Strategic Management Review*, 2015: 66-80.
- Zevallos, E. 2013. *Agenda de competitividad para la región Huetar Norte: caracterización socioeconómica de la Región Huetar Norte* . San José, Costa Rica. Agenda de competitividad para la región Huetar Norte.
- Zeydan, M; Çolpan, C; Cobanoğlu; C. 2011. A Combined methodology for supplier selection and performance evaluation. *Expert Systems with Applications*: 2741-2751.
- Zhu, Q; Sarkis; J. 2004. Relationships between operational practices and performance among early adopters of green supply chain management practices in Chinese manufacturing enterprises. *Journal of Operations Management* (22) 265–289.
- Zouggari, A; Benyoucef, L. 2012. Simulation based fuzzy TOPSIS approach for group multi-criteria supplier selection problem. *Engineering Applications of Artificial Intelligence* 507-519.
- Zuckerman, E. 2003. On networks and markets .Rauch and Casella (eds). *Journal of Economic Literature* 545–565.

## **Annexes**

## Annex 1. Questionnaire for hotels and restaurants



Hoteles y Restaurantes- LA FORTUNA-2015 CATIE-2015

Encuesta N°. \_\_\_\_\_

(no llenar)

### Determinación de los factores condicionantes para la inclusión de proveedores agrícolas

El objetivo de la encuesta es conocer cómo se toman las decisiones de venta de productos frescos, específicamente naranja, papaya, plátano y yuca, para un estudio que analiza las decisiones de compra-venta de productos agrícolas. Este estudio es exclusivamente para propósitos de investigación académica y toda la información se manejará de manera confidencial, sólo se publicarán datos agregados. No se hará referencia ni a personas ni a instituciones particulares. Por lo anterior, le solicitamos su colaboración para completar la siguiente información.

#### I. Datos personales

- |                                    |                  |
|------------------------------------|------------------|
| 1. Nombre _____ (del entrevistado) | 3. Cargo: _____  |
| 2. Ubicación del hotel/rest: _____ | 4. Correo: _____ |
| nombre del hotel/restaurante       | 5. Telef: _____  |

#### II. Datos sobre productos

##### 6. ¿A qué precio por kilogramo compra los siguientes productos? \*\*

- |           |   |        |
|-----------|---|--------|
| 1 Papaya  | <input style="width: 100%;" type="text"/> | por kg |
| 2 Yuca    | <input style="width: 100%;" type="text"/> | por kg |
| 3 Piña    | <input style="width: 100%;" type="text"/> | por kg |
| 4 Plátano | <input style="width: 100%;" type="text"/> | por kg |

\*\*Si el dato se da en otra unidad, debe transformarse a kg

espacio para cálculos

##### 7. ¿Qué volumen en kilogramos compra semanalmente?

- |           |   |        |
|-----------|---|--------|
| 1 Papaya  | <input style="width: 100%;" type="text"/> | por kg |
| 2 Yuca    | <input style="width: 100%;" type="text"/> | por kg |
| 3 Piña    | <input style="width: 100%;" type="text"/> | por kg |
| 4 Plátano | <input style="width: 100%;" type="text"/> | por kg |

\*\*Si el dato se da en otra unidad, debe transformarse a kg

espacio para cálculos

##### 8. ¿Qué porcentaje (aproximado) de los siguientes productos agrícolas se desperdicia?

- |           |   |   |
|-----------|---|---|
| 1 Papaya  | <input style="width: 100%;" type="text"/> | % |
| 2 Yuca    | <input style="width: 100%;" type="text"/> | % |
| 3 Piña    | <input style="width: 100%;" type="text"/> | % |
| 4 Plátano | <input style="width: 100%;" type="text"/> | % |

##### 9. ¿A quién le compra los siguientes productos?

- |           |                       |                              |                       |               |
|-----------|-----------------------|------------------------------|-----------------------|---------------|
| 1 Papaya  | <input type="radio"/> | Pequeño o mediano agricultor | <input type="radio"/> | Intermediario |
| 2 Yuca    | <input type="radio"/> | Pequeño o mediano agricultor | <input type="radio"/> | Intermediario |
| 3 Piña    | <input type="radio"/> | Pequeño o mediano agricultor | <input type="radio"/> | Intermediario |
| 4 Plátano | <input type="radio"/> | Pequeño o mediano agricultor | <input type="radio"/> | Intermediario |

##### 10. ¿Por qué le compra a esta persona (s)/empresa (s)? \_\_\_\_\_

##### 11. Indique qué mecanismo utiliza usted para el proceso de compra a proveedores:

- |                                 |                       |
|---------------------------------|-----------------------|
| 1 Por medio de contrato verbal  | <input type="radio"/> |
| 2 Por medio de contrato escrito | <input type="radio"/> |
| 3 Sin contrato                  | <input type="radio"/> |



III. Educación, experiencia y capacitación

12. Indique cuál de los siguientes corresponde a su nivel de estudios:

- 1 Primaria incompleta
- 2 Primaria completa
- 3 Secundaria incompleta
- 4 Secundaria completa
- 5 Universitaria

13. ¿Ha participado usted en algún curso de capacitación desde que labora para este hotel/restaurante?

- 1 Si  0 No  Pase a la pregunta 17

14. ¿Cuál fue el tema del curso? \_\_\_\_\_

15. ¿Qué institución dio el curso? \_\_\_\_\_

16. Señale, qué tan importante fue el curso para su desempeño:

- 1 Nada importante
- 2 Poco importante
- 3 Importante
- 4 Muy importante
- 5 Extremadamente importante

17. ¿Cuántos años tiene de trabajar en el sector de turismo/abastecimiento?

años

18. ¿Pertenece el hotel/restaurante a algún grupo organizado de desarrollo?

- 1 Si  0 No Pase a la p. 21

19. ¿Hace cuántos años?

años

20. ¿En qué le beneficia pertenecer a este grupo? \_\_\_\_\_

IV. Criterios de sostenibilidad

21. ¿El hotel/restaurante tiene la certificación de turismo sostenible?

- 1 Si  0 No Pase a la p.23

22. Con respecto a la certificación, cuántas hojas tiene

- 1  de 1-3  de 1-3  
2  4 o 5  4 o 5

**Qué tan importantes son los siguientes criterios a la hora de tomar una decisión de compra a proveedores de productos agrícolas frescos, según la escala:**

Variables	+++	+	+-	-	---
	Extremadamente importante	Muy importante	Importante	Poco importante	Nada importante
	5	4	3	2	1
23. La cantidad de producto que pueda ofrecer el proveedor					
24. La calidad y del transporte del producto desde la finca					
25. El precio de los productos agrícolas					
26. La calidad de los productos					
27. El nivel educativo de la persona con la que negocia					
28. La distancia (lejanía del punto de producción)					
29. Los años de experiencia del proveedor					
30. La transparencia de las transacciones					

Variables	+++	+	+-	-	---
	Extremadamente	Muy importante	Importante	Poco importante	Nada importante
	5	4	3	2	1
31. Que el proveedor pertenezca a un grupo organizado					
32. El buen manejo de aguas y de desechos sólidos por parte del proveedor					
33. Que el proveedor ofrezca producción orgánica					
34. Que los productos hayan tenido acceso a irrigación					
35. Otra: Cual: _____					

**Complete cómo clasificaría usted cada una de las siguientes características dependiendo del tipo de proveedor que utilice:**

Si tiene más de un proveedor, clasifique ambos si P = productor agrícola, I = intermediario

Variables	+++	+	+-	-	---	
	Excelente	Muy bueno	Bueno	Regular	Malo	
	5	4	3	2	1	
	P	I	P	I	P	I
36. La cantidad disponible de producto						
37. La calidad y facilidad de transporte						
38. El precio de los productos agrícolas						
39. La calidad de los productos						
40. El nivel educativo del proveedor						
41. La distancia entre el punto de producción y el hotel/restaurante						
42. La experiencia del proveedor						
43. La transparencia de las transacciones						
44. Capacidad de organización del proveedor						
45. Manejo de aguas y de desechos sólidos						
46. Acceso a producción orgánica						
47. Acceso a buena irrigación en los sistemas de plantación						

**Muchas gracias por su colaboración**

## Annex 2. Questionnaire for farmers.



Pequeños y medianos productores agrícolas- LA FORTUNA-2015

CATIE-2015

Encuesta N°. \_\_\_\_\_

(no llenar)

### Determinación de los factores condicionantes para la inclusión de proveedores agrícolas

El objetivo de la encuesta es conocer cómo se toman las decisiones de venta de productos agrícolas, específicamente papaya, piña, plátano y yuca, para un estudio que analiza las decisiones de compra-venta de productos agrícolas. Este estudio es exclusivamente para propósitos de investigación académica y toda la información se manejará de manera confidencial, sólo se publicarán datos agregados. No se hará referencia ni a personas ni a instituciones particulares. Por lo anterior, le solicitamos su colaboración para completar la siguiente información.

#### I. Datos personales y familiares

1. Dirección finca: \_\_\_\_\_
2. Nombre: \_\_\_\_\_
3. Teléfono (s): \_\_\_\_\_ / \_\_\_\_\_
4. ¿Cuántas personas viven con usted?
5. Además de la agricultura, se dedica usted o un miembro de su familia a otra actividad económica:
1. SI
0. No  100% en p. 7. Pase p. 8
6. Cuál actividad productiva: \_\_\_\_\_
7. De sus ingresos familiares, cuánto corresponde a ingresos agrícolas:
1. 100%
2. 75%  más de la mitad
3. 50%  la mitad
4. 25%  menos de la mitad

#### II. Datos productivos

8. ¿Cuál es la actividad principal en su finca? \_\_\_\_\_
9. Además de (respuesta 8)... ¿Cuáles de los siguientes productos cultiva usted?
- |           |   |
|-----------|---|
| 1 Papaya  | <input style="width: 80px; height: 20px;" type="text"/> |
| 2 Yuca    | <input style="width: 80px; height: 20px;" type="text"/> |
| 3 Piña    | <input style="width: 80px; height: 20px;" type="text"/> |
| 4 Plátano | <input style="width: 80px; height: 20px;" type="text"/> |
10. ¿Cuál es el porcentaje de rechazo de su producto al realizar una venta? (según respuesta p.9)
- |           |   |   |
|-----------|---|---|
| 1 Papaya  | <input style="width: 80px; height: 20px;" type="text"/> | % |
| 2 Yuca    | <input style="width: 80px; height: 20px;" type="text"/> | % |
| 3 Piña    | <input style="width: 80px; height: 20px;" type="text"/> | % |
| 4 Plátano | <input style="width: 80px; height: 20px;" type="text"/> | % |
11. ¿A qué precio por kilogramo vende los siguientes productos? \*\* (según respuesta p.9)
- |           |   |        |
|-----------|---|--------|
| 1 Papaya  | <input style="width: 80px; height: 20px;" type="text"/> | por kg |
| 2 Yuca    | <input style="width: 80px; height: 20px;" type="text"/> | por kg |
| 3 Piña    | <input style="width: 80px; height: 20px;" type="text"/> | por kg |
| 4 Plátano | <input style="width: 80px; height: 20px;" type="text"/> | por kg |
- \*\*Si el dato se da en otra unidad, debe transformarse a kg
- espacio para cálculos
12. ¿Cuántos kilogramos a la semana vende de...? \*\* (según respuesta p.9)
- |           |   |        |
|-----------|---|--------|
| 1 Papaya  | <input style="width: 80px; height: 20px;" type="text"/> | por kg |
| 2 Yuca    | <input style="width: 80px; height: 20px;" type="text"/> | por kg |
| 3 Piña    | <input style="width: 80px; height: 20px;" type="text"/> | por kg |
| 4 Plátano | <input style="width: 80px; height: 20px;" type="text"/> | por kg |
- \*\*Si el dato se da en otra unidad, debe transformarse a kg
- espacio para cálculos
13. ¿A quién le vende su producto? (según respuesta p.9)
- |           |                       |                   |                       |   |
|-----------|-----------------------|-------------------|-----------------------|---|
| 1 Papaya  | <input type="radio"/> | Hotel/Restaurante | <input type="radio"/> | Intermediario (verdulería-supermercado) |
| 2 Yuca    | <input type="radio"/> | Hotel/Restaurante | <input type="radio"/> | Intermediario (verdulería-supermercado) |
| 3 Piña    | <input type="radio"/> | Hotel/Restaurante | <input type="radio"/> | Intermediario (verdulería-supermercado) |
| 4 Plátano | <input type="radio"/> | Hotel/Restaurante | <input type="radio"/> | Intermediario (verdulería-supermercado) |
14. ¿Por qué le vende a esta persona (s) /empresa (s)? \_\_\_\_\_

Por favor marque qué tan de acuerdo o desacuerdo está usted con cada una de las siguientes frases

Variables	+++	+	+-	-	---
	Totalmente de acuerdo	De acuerdo	Ni de acuerdo ni en desacuerdo	En desacuerdo	Totalmente en desacuerdo
	5	4	3	2	1
15. El precio pagado por los productos agrícolas es justo					
16. El dinero que recibe un agricultor por la venta de sus productos agrícolas le alcanza para darle las mejores oportunidades a su					
17. Existen muchas trabas para vender los productos agrícolas a un buen precio					
18. Las personas que trabajan en otra actividad tienen mejores oportunidades que los agricultores					

19. ¿Cuál cree usted que sería un precio justo para estos productos?

- 1 Papaya
- 2 Yuca
- 3 Piña
- 4 Plátano

20. A la hora de vender su producto, usualmente usted:

- 1 Utiliza un contrato verbal
- 2 Utiliza contrato escrito
- 3 Vende sin contrato

21. Indique cuál de los siguientes corresponde a su nivel de estudios:

- 1 Primaria incompleta
- 2 Primaria completa
- 3 Secundaria incompleta
- 4 Secundaria completa
- 5 Universitaria

22. ¿Ha asistido a algún curso de capacitación?

Si

No

Pase a la pregunta 26

23. ¿Cuál fue el tema del curso?

\_\_\_\_\_

24. ¿Qué institución dio el curso?

\_\_\_\_\_

25. Señale, qué tan importante fue el curso para usted (marque con X):

- 1 Nada importante
- 2 Poco importante
- 3 Levemente importante
- 4 Importante
- 5 Muy importante

26. ¿Cuántos años tiene de trabajar en el sector agrícola?

años

27. ¿Pertenece usted a algún grupo organizado?

Si

No

Pase a la p.30

28. Hace cuánto tiempo:  años

29. ¿En qué le beneficia pertenecer a este grupo? \_\_\_\_\_

Indique qué tan importantes son los siguientes criterios a la hora de tomar una decisión de venta

Variables	+++	+	+-	-	---
	Extremadamente importante	Muy importante	Importante	Poco importante	Nada importante
	(8,9,10)	(6,7,8)	(4,5,6)	(2,3,4)	(0,1,2)
30. La cantidad de producto que le pida el comprador					
31. El transporte desde la finca hasta el punto de venta					
32. El precio de los productos agrícolas					
33. La calidad de los productos					
34. El nivel educativo de su comprador					
35. Distancia (lejanía del punto de venta)					
36. Los años de experiencia del comprador					
37. La claridad de la negociación con el comprador					
38. Que el comprador pertenezca a un grupo organizado					
39. El buen manejo de aguas y de desechos sólidos					
40. La producción orgánica					
41. Acceso a riego					
42. Otra					

Marque cómo clasificaría usted cada una de las siguientes características a su comprador (debe especificar la calificación de cada tipo de comprador según respuesta 13)

Variables	+++	+	+-	-	---
	Excelente	Muy bueno	Bueno	Regular	Malo
	(8,9,10)	(6,7,8)	(4,5,6)	(2,3,4)	(0,1,2)
43. La cantidad disponible de producto					
44. La calidad y facilidad de transporte					
45. El precio de los productos agrícolas					
46. La calidad de los productos					
47. El nivel educativo del proveedor					
48. La distancia entre el punto de producción y comprador					
49. La experiencia del proveedor					
50. La transparencia de las transacciones					
51. Capacidad de organización del proveedor					
52. Manejo de aguas y de desechos sólidos					
53. Acceso a producción orgánica					
54. Acceso a buena irrigación en los sistemas de plantación					
55. Otra					

56. ¿A quién podría recomendarnos para llenar esta entrevista?

Nombre \_\_\_\_\_ Teléfono \_\_\_\_\_

Muchas gracias por su colaboración

### **Annex 3. Guide for La Fortuna's Stakeholders: In-depth Interviews**

CATIE-2015

#### **Encuestas Abiertas a Grupos de Interés para el proyecto: Modelling Dynamic Systems for Sustainable Supply Chains: a Case Study in La Fortuna**

Guía de Entrevista

Presentación del proyecto: objetivos, trabajo de campo, solicitud de colaboración.

1. Nombre, cargo.
2. ¿Cuáles son las principales actividades económicas en la zona?
3. ¿Cuáles son las principales actividades de... (la organización)?
4. ¿Cuáles cree usted que deban ser las opciones de desarrollo de la región?
5. ¿Cuáles son los principales problemas de la región y cómo cree usted que se puedan solventar?
6. ¿Cómo evalúa usted el desarrollo agrícola de la zona?
7. ¿Cómo evalúa usted el desarrollo turístico de la zona?
8. ¿Cuáles son las instituciones más importantes en la Fortuna para el desarrollo de ésta?  
(turismo, agrícola, otra)

## **Annex 4. Guide for La Fortuna's Farmer: In-depth Interviews**

CATIE-2015

### **Encuestas Abiertas a agricultores medianos y pequeños del proyecto: Modelling Dynamic Systems for Sustainable Supply Chains: a Case Study in La Fortuna**

Guía de Entrevista

Presentación del proyecto: objetivos, trabajo de campo, solicitud de colaboración.

1. Nombre, años de experiencia en agricultura.
2. ¿Qué tan importante en el sector agrícola para el país, la región?
3. ¿Le parece que los precios pagados al productor son justos? ¿Por qué?
4. ¿Le parece que hay suficiente apoyo para sector agrícola?
5. ¿Cuáles son las principales actividades económicas en la zona?
6. ¿Cree que la organización de los pequeños y medianos agricultores es importante? ¿Por qué?
7. ¿Por qué cree que no hay iniciativas locales para mejorar el trabajo conjunto entre agricultores de La Fortuna?
8. ¿Cuáles son los principales problemas a los que se enfrentan los pequeños y medianos agricultores en el país? ¿En la región?